

MESA/BOOGIE®



Owner's Manual

Hello from the Tone Farm

...You, smart player and intuitive human, have put your trust in us to be your amplifier company. This is something we do not take lightly. By choosing this instrument to be a part of your musical voice, you have become part of the Mesa family...WELCOME!

Our goal is to never let you down. Your reward is that you are the new owner of an amp, bred of fine all tube heritage...benefiting from the many pioneering and patented Mesa circuits that led to the refinement of your new model. We feel confident, this amp will inspire many hours of musical satisfaction and lasting enjoyment. It was built with you in mind, by players who know the value of a fine musical instrument and the commitment it takes to make great music. The same commitment to quality, value and support we make to you...our new friend.

IMPORTANT SAFETY INSTRUCTIONS

Read these instructions.

Keep these instructions.

Heed all warnings.

Follow all instructions.

Do not use this apparatus near water.

Clean only with dry cloth.

Do not block any ventilation openings. Install in accordance with the manufacturer's instructions.

Do not install near any heat sources such as radiators, heat registers, stoves, or other apparatus (including amplifiers) that produce heat.

Do not defeat the safety purpose of the polarized or grounding-type plug. A polarized plug has two blades with one wider than the other. A grounding type plug has two blades and a third grounding prong. The wide blade or the third prong are provided for your safety. If the provided plug does not fit into your outlet, consult an electrician for replacement of the obsolete outlet.

Protect the power cord from being walked on or pinched particularly at plugs, convenience receptacles, and the point where they exit from the apparatus.

Only use attachments/accessories specified by the manufacturer.

Unplug this apparatus during lightning storms or when unused for long periods of time.

Refer all servicing to qualified service personnel. Servicing is required when the apparatus has been damaged in any way, such as power-supply cord or plug is damaged, liquid has been spilled or objects have fallen into the apparatus, the apparatus has been exposed to rain or moisture, does not operate normally, or has been dropped.

To insure proper ventilation always make sure there is at minimum four inches (101.6mm) of space behind the rear of the apparatus. The ventilation should not be impeded by covering the ventilation openings with items, such as newspapers, tablecloths, curtains, etc. Do not impede ventilation by placing objects on top of the apparatus which extend past the rear edge of its cabinet.

No naked flame sources, such as lighted candles, should be placed on the apparatus.

The apparatus shall not be exposed to dripping or splashing and no objects filled with liquids, such as vases, shall be placed on the apparatus.

WARNING: To reduce the risk of fire or electric shock, do not expose this apparatus to rain or moisture.

The AC plug is the mains disconnect. The plug should remain accessible after installation.

WARNING: EU: permission from the Supply Authority is needed before connection.

WARNING: Always make sure proper load is connected before operating the amplifier. Failure to do so could pose a shock hazard and may result in damage to the amplifier.

Do not expose amplifier to direct sunlight or extremely high temperatures.

Always insure the amplifier is properly grounded. Always unplug AC power cord before changing fuse, tubes or removing chassis. Use only same type and rating when replacing fuse.

Avoid direct contact with heated tubes. Keep amplifier away from children.

To avoid damaging your speakers and other playback equipment, turn off the power of all related equipment before making the connections.

Do not use excessive force when handling buttons, switches and controls. Do not use solvents such as benzene or paint thinner to clean the unit.

Always connect to an AC power supply that meets the power supply specifications listed on the rear of the unit. Export models: always insure unit is wired for proper voltage. Make certain grounding conforms with local standards.

YOUR AMPLIFIER IS LOUD! EXPOSURE TO HIGH SOUND VOLUMES MAY CAUSE PERMANENT HEARING DAMAGE!

Your Mesa/Boogie Amplifier is a professional instrument. Please treat it with respect and operate it properly.

READ AND FOLLOW INSTRUCTIONS OF PROPER USAGE.



Table of Contents

Precautions _____	0
Overview _____	1-2

FRONT PANEL CONTROLS & FEATURES

MODES: CLEAN, CRUNCH, BLUES, BURN _____	3-4
INSTANT GRATIFICATION, HELPFUL HINTS _____	5
GAIN _____	6
TREBLE _____	6
MID _____	7
BASS _____	7
REVERB _____	7
MASTER _____	8
EQUALIZER SECTION _____	8-9
PRESET DEPTH CONTROL _____	9
CHANNEL POWER SELECT _____	10-11
SOLO CONTROL _____	11
CHANNEL SELECT _____	11
POWER _____	12
STANDBY _____	12

REAR PANEL CONTROLS, SWITCHES & JACKS

FUSE _____	13
FOOTSWITCH JACK _____	13
EXTERNAL SWITCHING _____	13
EFFECTS LOOP _____	14
SPEAKERS _____	14-15

FACTORY SAMPLE SETTINGS _____	16
PERSONAL SETTINGS _____	17
DIAGNOSING TUBE PROBLEMS _____	18-19
BIAS ADJUSTMENT ARTICLE _____	20-22
SPEAKER IMPEDANCE MATCHING AND HOOKUP GUIDE _____	23-28
FEATURE ARTICLE: ON PENTODES, TRIODES & IRISHMEN by Randall Smith _____	29-31
TUBE TASK CHARTS: 5:25+ & 5:50+ _____	32-33
PART SHEETS: 5:25+ & 5:50+ _____	34-35



Operating Instructions

OVERVIEW:

Congratulations on choosing one of the *Express Plus* models as your amplifier and welcome to the MESA Family! These amplifiers represent the latest generation of a time-proven circuit that has been evolving over the last 27 years. With inspiring Tone and a layout that's intuitive and easy to navigate, it's no wonder this model has become one of our most popular line of instruments.

We use the term instrument literally because you will quickly come to rely on the myriad of truly *Expressive* sounds in your amp as it becomes an integral part of your tone and your individual voice. Feel confident that, just like a fine musical instrument, we handcrafted your all-tube amplifier here in Petaluma, California adhering to a code that is centuries old...where patience and scrutiny are guiding every step on the way to excellence.

Both *Express Plus* models use the same super versatile, tone-packed preamp featuring two fully independent Channels, each of which contain two style enhanced modes to choose from when creating your footswitching preferences. Channel 1 hosts the blooming low-gain sweetness of CLEAN or the snarling mid-gain percussiveness of CRUNCH and covers the rhythm territories. Channel 2 offers a different face to mid-gain with the howling honesty of BLUES or a high-gain adventure through the searing layers of molten harmonics in BURN. Together these two inspiring modes invite years of solo exploration.

These stylistically opposing modes in the two Channels enable your *Express Plus* to roam many different genres of music with complete legitimacy. The R&B, Roots or Blues minded player would find themselves at home with Channel 1 set to CLEAN and Channel 2 set to BLUES, while the Rock, Metal or Punk influenced guitarist would likely prefer switching between CRUNCH and BURN. This ability to reconfigure the Channels and morph personalities creates a Jekyll/Hyde platform from where any classic or modern tone you are aiming at can be found in seconds. The ability to adapt is part of what defines a classic instrument.

Now the *Express Plus* features a dramatic enhancement in the EQ department with the inclusion of our time-honored 5 Band Graphic Equalizer! The SLIDERS are added in addition to the original Channel Assignable PRESET contour controls and you can now choose whether you want to use the SLIDERS or the PRESET in each Channel with the EQ Assign mini toggle. The EQ, whether set to call up the SLIDERS or the PRESET controls, is also footswitchable as well and can be called up at any time via the Express Plus Footswitch.

FRONT VIEW: *Express 5:25+*TM

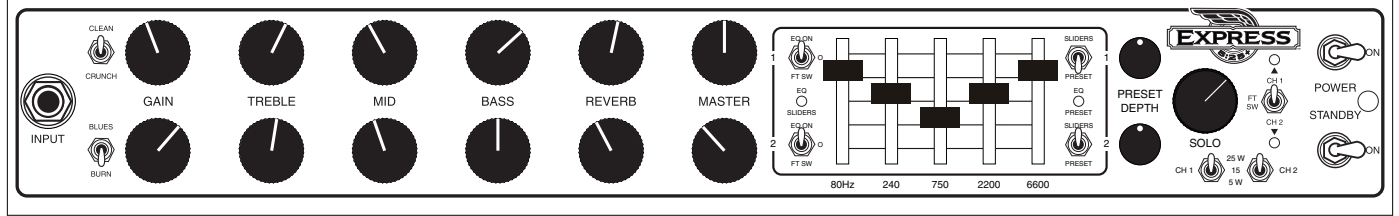

REAR VIEW: *Express 5:25+*TM

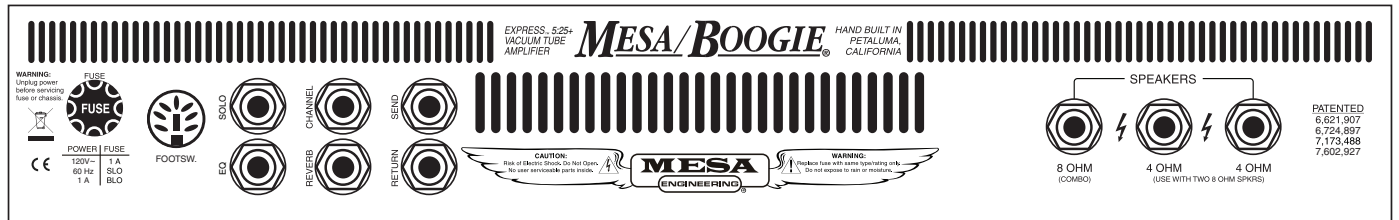

OVERVIEW: (Continued)

FRONT VIEW: *Express 5:50+*TM

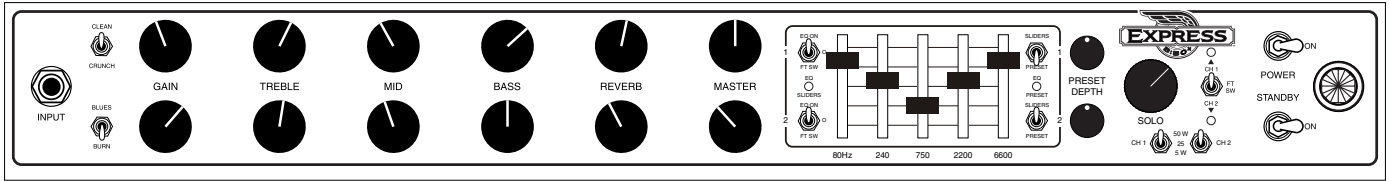

REAR VIEW: *Express 5:50+*TM



Rich all-tube REVERB enhances the spatial quality of your *Express Plus* and each Channel provides an independent Reverb Mix control so you can get the perfect blend of this beautiful effect for each of your footswitchable sounds. The Reverb effect can be triggered on and off via the included Footswitch.

Outboard Processing is handled by the series EFFECTS LOOP, keeping patching to a minimum and protecting tonal integrity a priority. The *Express Plus* amplifiers are compatible with most good quality processors and using this feature for all of your rack-type effects will produce gratifying results.

Both *Express Plus* models, the bouncy 25 watt *5:25+* with its 2xEL84 9-pin power tubes and the bolder 50 watt *5:50+* running 2x6L6 octal-base pentodes, feature our patented Multi-WattTM power switching. This valuable feature allows you to run the output tubes in three different wattage ratings per Channel – very cool right? But what's amazing is this – each power mode has its own tone-spawning operating class and wiring configuration! Choose the full power mode of either amp (25W in *5:25+* or 50W in *5:50+*) for Class AB running in a Push-Pull configuration for punch, authority and headroom. Or, kick down to 15 watts (25 watts on the *5:50+*) for Class A Pentode for a more silky, vintage voice with enhanced clip potential. And for the ultimate in low wattage power expression knock it down to the 5 watt mode... now you're running one tube in Class A Pentode wired in a Single-Ended configuration. Obviously we were thankful the patent office saw the possibilities and rewarded our efforts with a patent, but what excites us is the look on players faces when they hear and feel this power section magic for the first time. The *Express 5:25+* also features our patented Dyna-WattTM Power that creates a time-specific burst of headroom at the initial attack of the notes that far exceeds the rated power of the circuit and gives the *5:25+* an incredible sound and feel all its own.

Now that you have an overall picture of the features in your new *Express Plus*, let's move on to the specific modes and features.

FRONT PANEL: CONTROLS & FEATURES

THE MODES

CHANNEL 1

CLEAN: This is the lowest gain of the four modes in your *Express Plus* and it is voiced to deliver beautiful sparkling and warm clean chording sounds. The CLEAN mode has the greatest dynamic range of all the modes as the signal here is not compressed with any additional gain as are the other three sequentially. Because of this more traditional gain structure, many players that are looking for a vintage style response from the *Express Plus* should be at home here. At higher GAIN settings this mode delivers great old school lead sounds and if you are a player that is reliant on overdrive pedals for a certain sound (although we greatly encourage you to explore the other three modes – especially BLUES - for overdriven applications), CLEAN will likely be the best match for retaining more dynamic range.

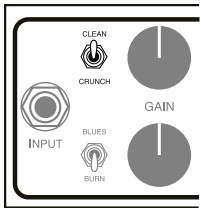

The taper of the GAIN control is calibrated such that at the lower settings 9:30 - 11:00 the sound will be very bright and skinny “and” as you approach 12:00 – 2:00 warmth and richness appears and the signal stays clean. From the 2:30 – 4:30 range a soft fur will begin giving way to a vintage style break-up and finally at its maximum setting (5:30) the signal will be fairly pushed and overdriven. Keep in mind that these are approximate descriptions of the sound and that your own personal playing style, guitar, pickups and most of all touch, will determine how this mode reacts at specific settings.

CRUNCH: This mode excels at higher gain rhythm sounds and though it is quite a bit gainier than the CLEAN mode, it’s voiced to retain as much dynamic range as possible. It cleans up nicely at the lower end of the GAIN control (9:00 – 12:00) and therefore can be used as an alternate type of clean sound, though it will always retain a bit more aggressive midrange and will not have as much top end sparkle as CLEAN.

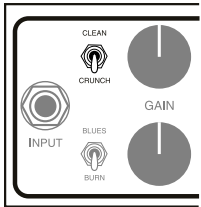

Between 12:00 – 2:30 is where the classic rock rhythm sounds live, especially with humbucking pickups and mahogany guitars. This is a sound that is overdriven, crisp and urgent, but not overly saturated. From 2:30 on up to the maximum GAIN setting (5:30), the sound becomes more saturated and begins to get a bit thicker and creamier. This region is great for solo sounds where more urgency is needed, as it has ample gain but is still tight tracking and responsive.

Be sure to experiment with the Graphic EQ (try the classic “V” setting) and The PRESET feature in the CRUNCH mode as some amazing sounds appear as a result of this combination. We tend to like the PRESET set at 12:00 with the GAIN at around 4:00 for a great rock rhythm sound. Again, these are approximate settings as everyone will have different styles, guitars, pickups and touch.

FRONT PANEL: CONTROLS & FEATURES (Continued)

CHANNEL 2

BLUES: Channel 2 is aimed more at single note soloing, although both of the modes contained in this channel work well for rhythm playing as well if the GAIN controls are set in their lower regions. BLUES is the lower gain of the two modes in this Channel and owns the zone between the CLEAN and CRUNCH modes. It delivers a classic, old-school voice that can be set to achieve anything from a warmer clean sound, through a purring, soft-clip break-up on up to a mournful, howling lead sound.

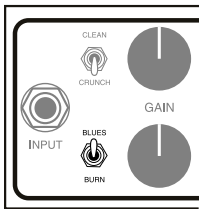

Because it derives its architecture more from a medium gain lead circuit, it will always be a little warmer and thicker than the CLEAN mode even at the lowest regions of the GAIN control. Therefore, if you wish to use BLUES as an alternate clean sound or, you prefer to use Channel 1 set to CRUNCH for an urgent lead sound and BLUES as your main clean, you will need to run the GAIN very low (9:30), the TREBLE higher (1:30 – 2:00) and the MID low (8:00 – 9:30). Following this scheme will give you the closest approximation of the scoop and sparkle present in the CLEAN mode.

When using the PRESET feature with the BLUES mode, you will likely find the best results in the lower range of the control (9:30 – 1:00). Above this region the mid-dip EQ curve of the PRESET can get a little too extreme for most players searching for bluesy solo sounds. However, this same curve can be a benefit to creating sweeter, more sparkling clean sounds as its mid-dip scoops some of the heavier mids that are needed for a fat single note sound, but can be a bit clunky for a great clean.

Also be sure to check out combining the BLUES mode with the 5 Watt Power setting to explore some really cool low-volume Blues magic. The single-ended wiring scheme utilized here produces a sweetness that enhances the BLUES mode perfectly... not to mention that your roommates will love you for it.

BURN: This is the highest gain of all the modes in your *Express Plus* and it is BURN that characterizes Channel 2 as the Lead Channel. As mentioned in the Overview, this circuit has been evolving over the last 27 years and after you've dipped your guitar into this river of undulating harmonics, you'll come away a new soloist...baptized by gain that's inseparable from the notes. Tight and focused, searing yet vocal, BURN delivers the ultimate in Expressive high-gain.

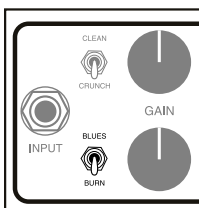

At the lower end (8:30 – 9:30) of the gain range you will find a small overlap with the top zone of the BLUES mode, although a bit fatter and more saturated, that offers some cool Blues or Roots melody line possibilities. The similarities end abruptly here and a wide region of amazing Rock sounds appear in the middle range (9:45 – 2:00) of the GAIN control. This is where you will likely find the most musical and versatile of your high-gain sounds...small adjustments here can make big changes in the attack and the body of the notes. From there on up

(2:15 – 5:30) the smoldering intensity of this channel is unleashed to produce a sound that is pure molten MESA. Legato and fluid, yet with beam-like clarity and sustain, BURN is testimony that 42 years ago on a mountainside in Marin County...we invented high gain.

Perhaps no other mode in your *Express Plus* showcases the power and sonic potential of the GRAPHIC EQ and the PRESET feature like BURN. Here, the entire range of the PRESET control produces useful and in fact, phenomenal high gain sounds. The lower (8:30 – 11:00) range combined with lower GAIN settings works great for widening mid-gain single note solo sounds, while higher settings (11:30 – 5:30) combined with more GAIN unveil a wall of crushing aggression that can be similar to our own Dual Rectifier™ line. Once you've auditioned the curve of the PRESET control, you can engage the EQ SLIDERS and begin shaping your own custom curve. Be sure to explore this hellacious realm of sounds when you're ready for some really big guitar sounds.

FRONT PANEL: CONTROLS & FEATURES (Continued)

INSTANT GRATIFICATION

Sweet Clean / Howling Blues

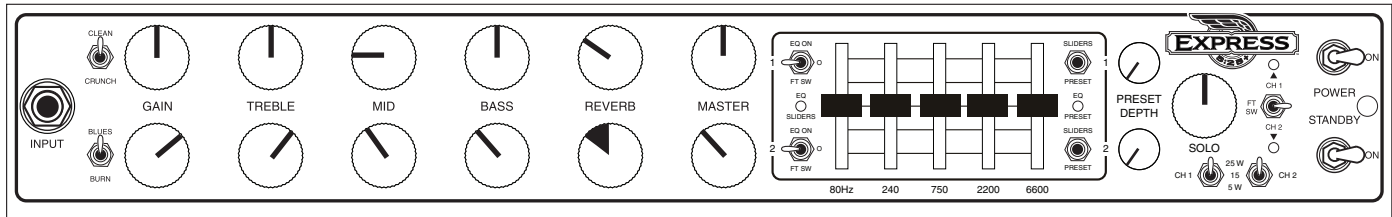

Big Crunch / Burning Lead

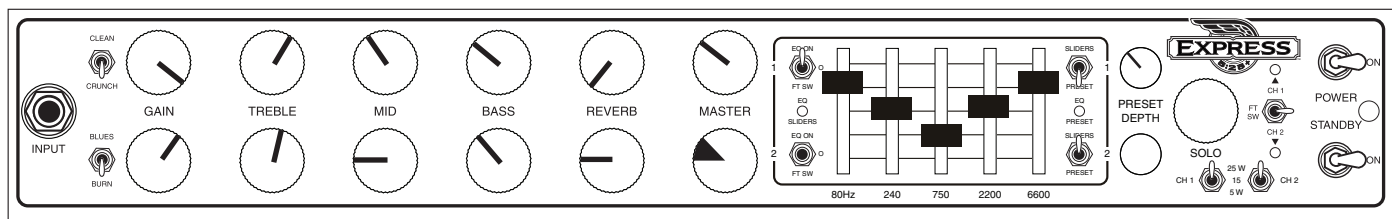

HELPFUL HINTS

1. The Controls are powerful. You will find great performance using most of the Controls set in their middle ranges and not in the extreme regions of their sweep. Try this approach first and venture beyond for specific needs.
2. As you increase the GAIN control – decrease the BASS control. This is a good practice throughout the Modes as it helps keep the sounds tracking accurately and helps avoid a loose, flubby attack. It is also advisable when searching for the maximum headroom for rhythm playing in the CLEAN mode.
3. Use the EQ Section as a seasoning element and not the main course. Dial in your sounds in the Modes with the rotary Tone Controls first and then engage the EQ for fine-tuning. (Exception: High Gain Crunch or Metal sounds – Use Sliders set to “V” curve or PRESET around 2:00.
4. Single 12” speaker should be connected to the 8 Ohm SPEAKER OUTPUT. Two 8 Ohm speakers should be connected to the 2 x 4 Ohm jacks (or one 4 Ohm jack if using a 2x12 wired to 4 Ohms.)
5. When using the EFFECTS LOOP, Delay, Reverb, Chorus, Flange, Harmonizers (virtually all “time-based” processors) and outboard Equalizers work well at this point in your signal path. When using Overdrive pedals, Wah-Wah, Envelope Filters and most other processors that affect the “guitar’s signal” and aren’t among those mentioned above, it is best to use them on the “front end” of the amplifier – between the instrument and the INPUT jack. This is not a hard and fast rule and deviating will not damage the amplifier, but the above wiring scheme will deliver the best tonal results and signal to noise ratio.
6. It is always preferable to have the combo - or extension cabinet if using a head - on the floor. This helps couple the low end and improves both the Tone you hear and the tactile sense you feel when playing. If you need the controls up higher to more easily reach them or want the sound to be aimed higher for projection on low stages, you might try adding an extension cabinet to your setup. However you achieve it, your amp will sound bigger and wider with at least one cabinet in contact with the floor.

Now let’s move to the individual controls and go over how they interact to achieve the sound you’re looking for.

FRONT PANEL: CONTROLS & FEATURES (Continued)

GAIN: As with all tube amplifiers, especially those with higher **GAIN** circuits, the **GAIN** control is by far the most powerful control in the amplifier. It determines the overall **GAIN** amount you will be working with (how clean or saturated the signal is) in any given channel or mode by metering the signal in the beginning stages (first tubes) of the preamp. It is also a very important Tone control as well.

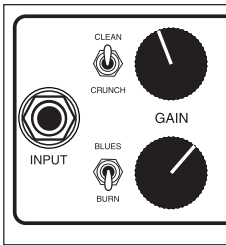

Generally speaking, lower the settings of the **GAIN** control (below 12:00 in all modes) produce sounds that are less saturated, cleaner, brighter and more dynamic. As the **GAIN** control is increased the sound begins to get thicker and warmer and the dynamic peaks get softened by natural, sweet tube compression as the signal moves toward saturation. This is pretty much an across the board (or Channels) response, as these global behavior traits remain constant regardless of the individual architecture of the modes themselves.

Another simple guideline to follow that might make dialing for your sounds easier is this; as the **GAIN** goes up...the **BASS** should come down. Following this scheme will help you avoid flub and retain a tight, focused attack.

So for example, if you are in Channel 1 **CRUNCH** and you want to max the **GAIN** (5:30) for a rhythm sound, you would want to run the **BASS** control somewhere around 10:30 or lower to keep the sound tracking tight. In the **BLUES** mode of Channel 2, things would be a bit more flexible. If you wanted to run the **GAIN** just high enough to have a nice fury break-up when you lean into it (1:00 – 2:00), you will be able to run the **BASS** a little higher (11:00 – 12:00) because there is less **GAIN** in the mode to begin with and you are not using an extreme setting of the **GAIN** control.

NOTE: If you need very high **GAIN** settings to achieve the type of sound you are after, try looking to the **CONTOUR** for any added low-end enhancement as this circuit comes later in the preamp and is less likely to “bloat” the sound. If the top-end enhancement is unwanted, reduce the **TREBLE**.

Just remember that as the internal gain structure of the Modes gets increased across the Channels, so does the need to carefully blend the **GAIN** and **BASS**, and in fact all the controls, to keep balance and cohesiveness in your Tone.

NOTE: Avoid extreme settings of both **GAIN** and **TREBLE** at the same time as the likelihood of annoying microphonic tube problems increases. If you need one set high to achieve the sound you are after, reduce the other to ensure uninterrupted performance.

TREBLE: As in most tube guitar amplifiers, the **TREBLE** control (in both channels of your *Express Plus*) is the most powerful of the rotary controls and is next in line only to the **GAIN** control as a shaping tool. Because it is first in the signal path of the tone controls - and from here the Middle and Bass receive their signal - it is by far the dominant tone control. For this reason the setting of the **TREBLE** control is very important for equal representation of the three frequency regions to appear at their respective controls. Like most of the controls on your *Express Plus*, there is an optimum region of the **TREBLE** control where ample top end is mixed in and yet enough signal is still passed on to the **MIDDLE** and **BASS** controls.

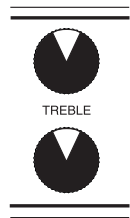

As you might surmise, here is the *sweet spot*. There are definitely great sounds above and below this middle region (11:00 - 1:30), but the balance between the **TREBLE** control and the other two tone controls is compromised.

FRONT PANEL: CONTROLS & FEATURES *(Continued)*

MID: The **MID** control is responsible for the blend of midrange frequencies in the mix and though its effect is not as dramatic as that of the **TREBLE** control, it plays an integral part in achieving any sound in your *Express Plus*. It is capable of changing the feel dramatically as it blends in a group of frequencies that tend to soften or stiffen the way a sound feels to play.



Most players tend to lean in the direction of lower **MID** control settings (7:00 - 11:00) where a scoop in this region produces *girth* (by letting the Bass become a little more dominant) and a lack of punch lends a more compressed, *even* feel to the strings and therefore less apparent resistance to the pick. As the **MID** control is increased, (11:30 - 1:30) the sound is rounded-out and filled-in with a focused mid attack appearing rather quickly. As you would guess, the feel starts to change - becoming more resistant. Above this region the **MID** control could be used to compensate for either weaker pick-ups or for times when a specific deficiency is produced by either an extremely high setting of other tone controls, or a physical anomaly in the room. While these **MID** control settings (2:00 - 5:00) can introduce added gain and create enhanced focus, the trade-off will be a stiffer, more forward, less compressed feel.

BASS: The **BASS** control in your new *Express Plus* works similarly in both channels in that it determines the amount of low frequencies present in a sound. However, the *style of lows* it mixes in changes from channel to channel. Like the **MID** control, it falls in line signal-wise *after* the **TREBLE** control and the same scheme applies. When the **TREBLE** control is set high, the effectiveness of the **BASS** and **MID** controls is reduced. If the **TREBLE** control is set low these two controls become dominant.



For the most balanced sound and a balance of power between the three rotary tone controls, try to use the **TREBLE** control in its middle ranges. This scenario produces nearly equal representation of all the frequencies on the tone controls and provides a great neutral starting point for further tweaking.

Note: The **BASS** control in both channels of your *Express Plus* is very powerful and though we have taken steps to ensure a balanced tone is easy to achieve, it is wise to blend with subtle nuance in mind. A good rule to follow is this; as you increase the **GAIN** reduce the **BASS**. Following this scheme will retain balance and keep the attack of the notes tight, dynamic and touch sensitive.

REVERB: Your new *Express Plus* amplifier is equipped with a rich, natural sounding all-tube Reverb circuit. The **REVERB** control enables you to dial-in just the right amount of Reverb to be mixed with the dry signal. It is normal for extreme settings of the **REVERB** control to slightly alter the character of the amplifier as the voicing of the Reverb circuit becomes more dominant in the mix.



NOTE: Avoid using high setting the **REVERB** control when High Gain and Treble settings are in use. This reduces the likelihood of annoying microphonic problems occurring.

FRONT PANEL: CONTROLS & FEATURES (Continued)

MASTER:

This control is the master feed from the end of the pre-amp to the driver stage and the Effects Loop. As you can see each Channel is fitted with its own **MASTER** control, enabling both channels relative volumes to be matched regardless of their extremely different sound styles and gain signatures. The **MASTER** control makes possible a wide range of sounds through its ability to use very low Gain sounds at high volumes and conversely, high Gain sounds at low volumes and everywhere between.

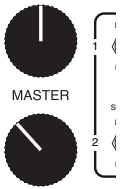

Again, we suggest using the **MASTER** control in its *sensible* ranges (9:00 - 2:00). Here, the channels will be easier to match with each other and the Effects Loop will see more reasonable signal levels.

NOTE: Because the **MASTER** control creates the send to the Effects Loop, extreme settings will cause a large signal to be sent to the Loop for that Channel. Not only may this cause possible overloading of the processors Input stage, but will make balancing both channel's Effect Send level difficult.

EQUALIZER SECTION:

This section of the *Express Plus* offers two additional ways to further shape your sound beyond what the standard array of rotary Tone Controls can do. The choices are either the classic Boogie 5 Band Graphic EQ or our PRESET DEPTH Control - which uses the same EQ circuitry to create a dial-able EQ version on one control that is pre-shaped to the iconic mid-dipped "V" slider setting. These choices are channel specific so that you can use either SLIDERS or PRESET for each Channel. Once you've chosen which option you want to use for each Channel, they can be auto-engaged when the Channel is selected, brought in and out via the Footswitch or Bypassed altogether.

Here are the switches, controls and the functions they perform to control the EQ section.

EQ CONTROL: Toggle

These two stacked 3-position mini-toggles to the Left of the SLIDERS (one for each Channel) in the EQ Window selects if and how you wish to engage the EQ Section – EQ ON, OFF or FT SW. Between the two mini-toggles in the centerline between the Channels, is an Orange LED that indicates when the EQ SLIDERS are engaged. When this light is illuminated, the EQ circuit is Active and you may use the SLIDERS to shape your sound (to use the PRESET Control, select PRESET with the EQ Style switch to the Right of the SLIDERS).

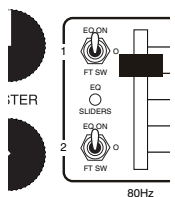

The Middle position of each switch (O) Bypasses the EQ section altogether and both SLIDERS and PRESET will not have any effect on the signal.

The Upper position of each switch (EQ ON) engages the EQ section in that Channel. Whatever is selected on the EQ STYLE mini- toggle (to the right of the SLIDERS) will determine the type of interface that is active in that Channel... SLIDERS or PRESET.

The Lower position of each switch (FT SW) allows you to engage the EQ section from the *Express Plus* Footswitch. The Footswitch EQ button may not turn the EQ on or off if the EQ Control switch is set to either EQ ON or O (switch up or switch middle) as these positions override the Footswitch EQ button.

FRONT PANEL: CONTROLS & FEATURES (Continued)

EQ STYLE - Toggle:

These two stacked 2-position mini-toggles to the Right of the SLIDERS (one for each Channel) determine the style of interface you wish to utilize to control the EQ circuit. As mentioned earlier, there are two ways to use the EQ circuit – the traditional Graphic EQ SLIDERS and the PRESET DEPTH Rotary Control. Just between these switches (on the centerline between the Channels) is located a Red LED that indicates the PRESET circuit and Rotary Control are active. When this LED is illuminated, the PRESET control is engaged and the 5 SLIDERS have no effect on the signal.

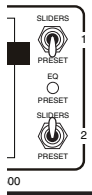

The SLIDERS position allow you to dial in specific curves on the “graph” to suit your individual needs for different instruments, playing styles and room variations.

The PRESET circuit does the work for you and puts the shaping power of the EQ under one simple rotary control that you can turn up and down quickly. The PRESET uses the same circuit as the SLIDERS and sets the “EQ Curve” internally to the classic “huge-approved” mid-dipped “V” setting.

NOTE: The indicator LED above the EQ button on the Footswitch is a dual-color type that tracks the colors on the Front Panel EQ LED indicators. It will appear orange for SLIDERS and change to green when PRESET is activated.

GRAPHIC SLIDERS:

These are the five fader style potentiometers for the Graphic EQ. They are centered on the five frequency points we’ve found most effective for shaping guitar sounds quickly and accurately. So that they are “less tweaky” and interact smoothly. They incorporate a fairly wide “Q” and are each capable of 12db of cut or boost.

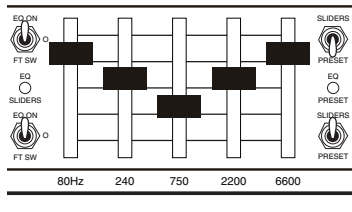

By far the most widely used is the 750Hz, which is used most often to cut midrange and create a scoop that makes the sound wider and more three-dimensional. Usually this mid cut is combined with a boosting of the 80 and 240 Hz as well as the 2200 and 6600 bands as well. This creates the classic “V” setting that so many Rock and Metal players rely upon for their huge crunch sound. While this is the most popular setting, there are many uses for the Graphic EQ from subtle enhancement to wild alteration of the signal and your own imagination is the only limit to the possibilities.

PRESET DEPTH CONTROL:

The PRESET DEPTH control takes the place of the 5 EQ Sliders as the interface to the EQ Circuit when you’ve selected PRESET on the EQ STYLE switch. As you increase the PRESET DEPTH Control from 7:00 / Off (a flat setting equivalent to all 5 SLIDERS set on the Center Graph Line) through its range, the mids start to dip and both low and high end are slowly boosted - until at 5:30 (maxed out) - you have an extreme mid-dipped “V” setting. This dial-able enhancement allows for some subtle applications of the EQ circuit at the low end of the control that can be superior to the SLIDERS for certain sounds because it acts as an EQ “mix” control at these lower settings.

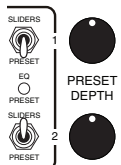

For example, apply a slight bit of the PRESET to make chording sounds blossom in CLEAN - or turn it up just a bit more to add bounce and girth to rhythmic parts in the BLUES Mode. This PRESET EQ treatment works well for all the MODES, but showcases its true power most in the CRUNCH and BURN MODES - where this “V” curve produces some radical and now iconic Rock and Metal Crunch chording sounds. This sound has been a live power-tool as well as a much-recorded staple of Rock and Metal guitarists that have played our MARK Series models for decades. Now this dual-option EQ comes straight from our Flagship MARK FIVE to greatly enhance the flexibility of the *Express Plus*.

FRONT PANEL: CONTROLS & FEATURES (Continued)

CHANNEL POWER SELECT: MULTI-WATT™ Channel Assignable Power

As mentioned in the OVERVIEW, your

Express Plus features our patented Multi-Watt™ Power, which allows you to switch between three power ranges that run in both different Classes of Operation and different Wiring Configurations. You will only find this powerful feature on MESA amplifiers and it allows you to tune the power section for volume, Tone and feel... optimizing its response for higher volume gig applications or lower volume recording and inspiring practice sessions

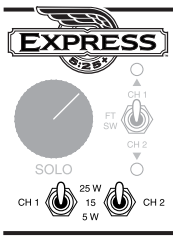

25 WATT

50 WATT

The Full Power setting (50 watts in *Express 5:50+*, 25 watts in the *Express 5:25+*) runs in Class A/B and is wired in a Push-Pull Configuration. This position (switch up) delivers the full rated power and would be the choice any time you need headroom for clean sounds or bold, tight authority for all the sounds while playing with other musicians. Class A/B, when combined with a pair of output tubes wired in a Push-Pull configuration, is the most efficient operating class and style of wiring and this scheme emphasizes upper mid punch, low-end clarity and upper harmonic cut.

NOTE: 5:25+ Owners! You've probably noticed by now that your *Express Plus* seems far louder and more dynamic than any other 25 watt amp you've heard. This is due to Dyna-Watt™, our patented way of wiring up a pair of EL84 output tubes that delivers a massive burst of headroom at the initial attack of the note. From there a "timed sag" circuit loosens the feel as the notes decay and the result is a little amp that is twice as powerful as its rated wattage on the attack – where you need it – but sweet and clippable, bouncy and dynamic as the sound decays. The *Express 5:25+* with Dyna-Watt™ is one of our most enjoyable circuits to play as it is extremely Expressive and friendly feeling on the strings as well as incredible sounding...*5:50+* owners, check one out sometime!

15 WATT (25 Watt in the Express 5:50+)

This position utilizes both power tubes running in Class A to create a lower wattage option that sweetens the top end and adds warmth while delivering a lower clip threshold. The pair of EL84's runs in Class A pentode, but here delivers the softer transition into clip and sweet upper harmonic detail and smoothness Class A circuits are famous for. Though technically a low power rating, the 15 WATT (25 WATT in *5:50+*) setting is still quite loud and therefore capable of some ample gig volumes, especially when you want some attitude in your "clean" sound and don't need the highs or lows to be squeaky clean.

This Power Mode is the choice when you're looking for Blues or Roots sounds (in the CLEAN and BLUES Modes) - and have a front end GAIN setting that uses a bit of preamp drive – still basically clean and responsive to dynamic content – but right at the threshold of where it relies on power sensitivity for most the overdrive component. There is a whole range of applications for the transitional region this Power Mode features from purring Blues Solo sounds to Alternative furry chording or any time you need to be able to lean into it and ride the power clip.

Another application of this Power Mode is creating liquid smooth high gain solo sounds in BURN. The character here is creamy and compressed and the feel is more legato and forgiving. Be sure to try the CRUNCH Mode as well with the 15 Watt setting (25 WATT in *5:50+*) – as this combination creates some amazing medium to high gain sounds for layered chording and singing sustain for single notes.

Some players love the 15 WATT (25 WATT in *5:50+*) setting so much they use it all the time, citing the perfect balance of Tone, head-room and power expression (clip-ability). While we do agree with this view to some extent, and certainly the 15 WATT Power Mode (25 WATT in *5:50+*) does offer a beautiful balance of power attributes, it is but one of the faces of power contained in the Multi-Watt palette. We suggest exploring them all and applying each of these different and expressive Power Modes according to its virtues.

FRONT PANEL: CONTROLS & FEATURES (Continued)

5 WATT

This position (switch down) reconfigures everything in your power section! The operating Class is also switched to Class A Pentode, which is far less efficient - but produces smooth, rich, silky harmonics and warm low end. Many of the most prized vintage amplifiers were built with this operating class. Now here is where we get tricky and this is the basis of our patent. The wiring configuration is switched as well - from Push-Pull to Single-Ended. This configuration - the first way tubes were ever wired – is again far less efficient but puts emphasis on the even order harmonics. Among these are the second harmonic that lives one octave above the notes that are being played and they're the most pleasing of all harmonics. They sound sweet and add a fullness to the sound like no other, almost like a super subtle octaver that is way back in the mix. Push-Pull circuits cancel out this second harmonic when the wave form is split in half and each half is amplified separately and the sweet second harmonic is replaced by the punchier “odd-order” third harmonic. Though less pleasing, the 3rd harmonic helps things cut through the mix and add power, thus the substantially louder impact of the Push-Pull configuration. Use the 5 WATT setting anytime you want the sweetest little amp response at home or in the studio. It produces gorgeous clean sounds at very low volumes and when pushed, clips in the coolest way...even beyond our favorite vintage classics.

The tone and versatility of this three mode power section leaves most other circuits with option envy. It's truly like having three amps in one package. And when you start combining the power choices with the myriad of sounds in the two Channels, the possibilities for authentic and inspiring sounds are near limitless.

SOLO CONTROL:

The SOLO™ control is a footswitchable Master Volume that enables a boost in volume for the whole amp. Here you can dial up a preset amount of boost and switch to it when it's time to step out for solo passages or any time you want to showcase a part. Simply set your desired overall playing level with the Channel MASTER Controls, Select SOLO on the *Express Plus* Footswitch and set the desired increase in volume level with the SOLO control.

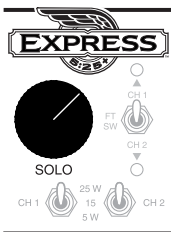

NOTE: The SOLO control may only be used to increase the volume beyond the level of that set by the Channel MASTER Controls. You cannot use the SOLO to switch to a level lower than that set by the Channel MASTER Control.

NOTE: Check the setting of the SOLO control before switching it in - as it may be set high and cause a shocking increase in volume.

CHANNEL SELECT:

This 3 position mini toggle allows manual selection of the Channels when the Footswitch is not connected. When the switch is in the CH. 1 (switch up) position Channel 1 will be activated and the green LED will be illuminated. The center position labeled FT SW activates the footswitch. The lower position, CH. 2 (switch down) activates Channel 2 and the red LED will come on.

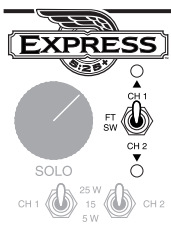

NOTE: When the Channel Select switch is in the FT SW (center) position and the Footswitch is not connected, the default setting is Channel 1 active.

NOTE: The indicator LED above the CHANNEL button on the Footswitch is a dual-color type that tracks the colors on the Front Panel Channel LED indicators. It will appear green in Channel 1 and change to red when Channel 2 is activated.

FRONT PANEL: CONTROLS & FEATURES (Continued)

POWER: This switch delivers the A.C. power to the *Express Plus*. Make sure the unit is properly grounded (all three terminals of the A.C. power cord must be connected whenever possible and that the proper voltage is present. Follow the cold start procedure described in the ON/STANDBY section above when powering up your new *Express Plus* amplifier.

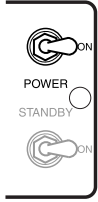

NOTE: Never alter the A.C. power cord in any way.

STANDBY: Perfect for set breaks...this toggle switch also serves an even more important purpose. In the **STANDBY** position (switch left), the tubes are at idle so that during power up they may warm up before being put to use.



Before the power is switched on, make sure the STANDBY switch is in the STANDBY position. Wait at least 30 seconds and then flip the **STANDBY** switch to its **ON** position. Following this simple warm up procedure helps in preventing tube problems and increase their toneful life substantially.

Now let's spin your *Express Plus* around and cover the Rear Panel Features.

REST AREA

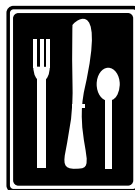
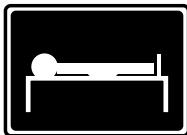

REAR PANEL: CONTROLS & FEATURES



FUSE: This is the main AC fuse that protects your amplifier from damage should a tube ever fail or you receive a surge from the AC wall socket. Always replace the fuse with the same type and rating to avoid damage to your amplifier. Failure to do so will likely cause damage and void your warranty. Both *Express Plus* models use a Slo-Blo type fuse.

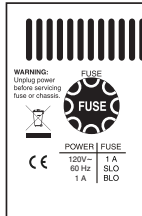

Express 5:25+ = 1 AMP Slo-Blo Fuse
Express 5:50+ = 3 AMP Slo-Blo Fuse

FTSW (Footswitch): This 8 pin female DIN jack accepts the Express Plus Footswitch. It is NOT a standard 5-pin midi cable and if you lose your cable, it will be a special order for any music store and therefore more easily obtained through your local MESA dealer or through us directly. It is a standard 8 pin DIN cable and you might be able to find it through some electronics supply houses or computer parts retailers as well.



Make sure the cable is securely seated all the way into the jack when setting up your amplifier.

It's always advisable to carry the Footswitch and cable in either the pouch provided - or in a separate gig bag rather than tossing them in the back of your combo cabinet. Loose articles floating around in the back of your amp can damage both tubes and speakers during transport. Don't arrive at the gig with your amp damaged from the Footswitch or cable because you were in a hurry and didn't pack it properly

EXTERNAL SWITCHING: These four 1/4 " jacks trigger the SOLO, CHANNEL, EQ and REVERB feature of each Channel when you want to control your *Express Plus* with a master external switcher. In this way you can call up the sounds on your *Express Plus* remotely without connecting the Footswitch and have your effects and amp sounds respond to a single button (possibly midi) program change command.



Simply connect standard unshielded (speaker) 1/4" phone cables to these four jacks and short the "tip" to "ground" to activate the features. This standard tip-to-ground "latching type" logic is supported on most all master switching devices, so all you will have to do is program what ports on your switcher will be grounded under which programs.

REAR PANEL: CONTROLS & FEATURES *(Continued)*

EFFECTS LOOP:

The *Express Plus* incorporates an internal **EFFECTS LOOP** to handle the interfacing of outboard processing. This circuit is a patch point between the preamp and the power section and it is wired in series with the dry (unaffected) signal. Since this loop is a series-type loop (as opposed to parallel - where the loop signal runs alongside the dry signal) it is important that you use good quality processors “in the middle” of your amp. While the loop is compatible with most processor Input/Output impedance demands, there can be a lot of room for sonic compromise in some of the less expensive units. Remember that every part in your signal path is a tone part.

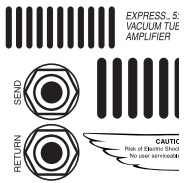

NOTE: Always use good quality shielded cable of the shortest possible length when patching your effects. One foot lengths are preferable - with lengths of more than 3 feet (each cable) starting to roll off top end and reduce upper midrange punch and top end clarity.

To use the **EFFECTS LOOP**;

- 1) Connect the SEND jack to your processor's Input
- 2) Connect the RETURN jack to your processor's Output
- 3) Adjust the processor's Input/Output Level attenuator to achieve unity gain while plugging the RETURN cable in and out making fine adjustments at the processor until you hear no level difference.

NOTE: The **EFFECTS LOOP** is optimized for professional quality rack mount processors. Most pedal type effects work better in the “front-end” between your instrument and the INPUT. You may experience some tonal changes because of the additional cable and the fact that your instrument will no longer be going straight into the grid of the first tube. It's up to you to decide if the trade off is acceptable.

NOTE: With a delay in the Loop – it is normal to experience a brief volume surge when switching between Channels set to different Multi-Watt Power Settings. This occurs due to the Channel MASTER controls being the SEND source for the Loop - and they can be set differently for different wattages to achieve balance between the channels.

SPEAKERS:

These jacks handle the output to speaker cabinets or the internal combo speaker in your *Express Plus*. There is one 8 Ohm and two 4 Ohm jacks here and between these outputs, most popular speaker combinations can be accommodated.

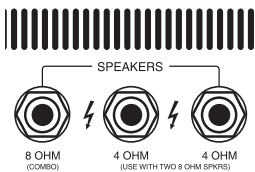

You'll find that different impedance loads change the way your amp sounds and feels - and though it is usually best to match the load you are using to the matching SPEAKER impedance output – you may find a certain mismatch combination to your liking. For example, some players like the tighter, bolder correct-match-response of an 8 Ohm speaker on the 8 Ohm SPEAKER output. Others may prefer the scoopier, more elastic vibe of the 8 Ohm speaker on the 4 Ohm jack.

REAR PANEL: CONTROLS & FEATURES *(Continued)*

COMBO: *Express Plus* combos use either one internal 8 Ohm speaker or, two 16 Ohm speakers (wired in parallel) to produce an 8 Ohm load. If you wish to use an extension speaker cabinet, you will need to remove the combo's speaker from the 8 Ohm SPEAKER output and connect it and the extension cabinet (also 8 Ohms) to the two 4 Ohm jacks for a correct impedance match.

HEAD: *Express Plus* heads can be used with most any speaker enclosure. Most MESA cabinets 1x12, 2x12 and 4x12 are wired to 8 Ohms. If you intend to use a non-MESA cabinet (we're sure you'll find our cabinets superior both in sound and construction) that is wired to 16 Ohms, connect it to the 8 Ohm SPEAKER output.

Now that we've covered the features and operation of your *Express Plus*, it's time to enjoy the best part...the sound and feel! We wish you many years of inspiration, fulfillment and musical satisfaction from your new *Express Plus*.

FACTORY SAMPLE SETTINGS

Roots Clean / Texas Lead

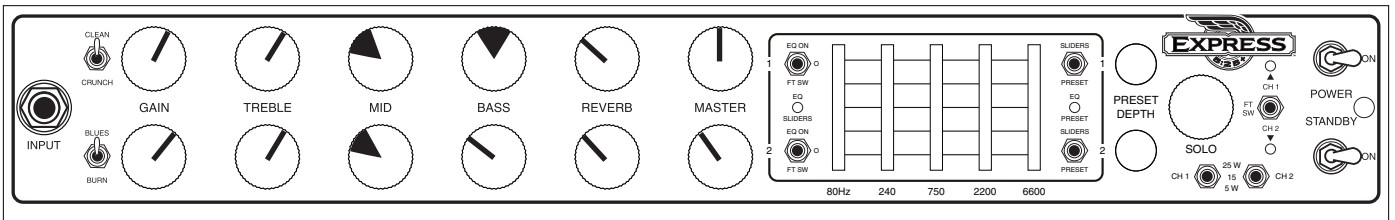

Spankin' Clean / Vocal Lead

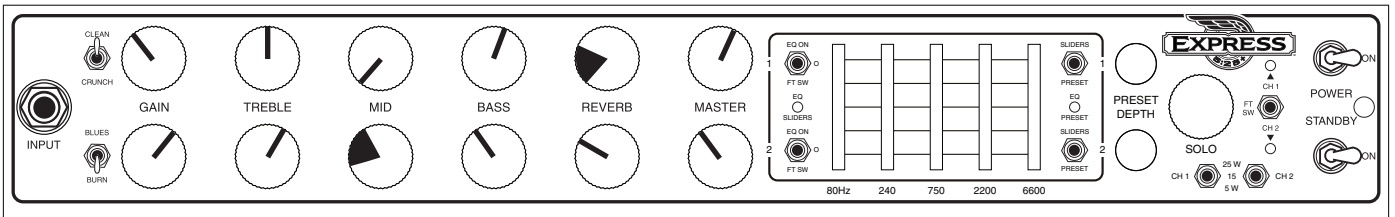

Pushed Clean / Thick Crunch

(EQ Optional)

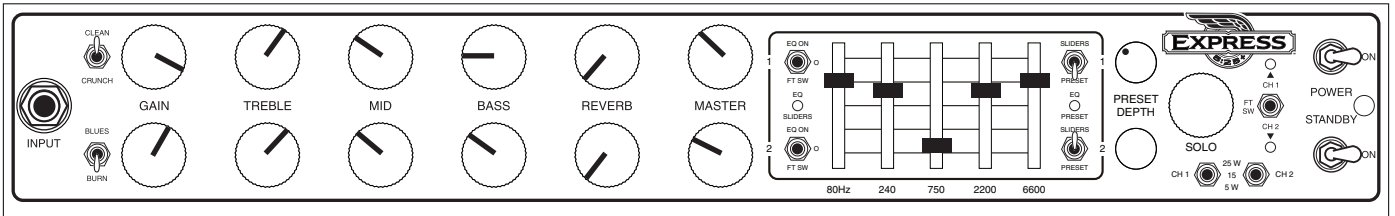

Tight Crunch / Soaring Lead

(EQ Optional)

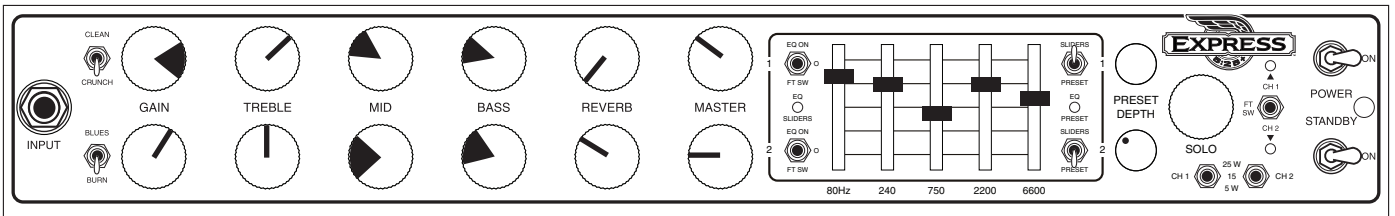

Alternative Clean / Huge Crunch

(EQ Optional)

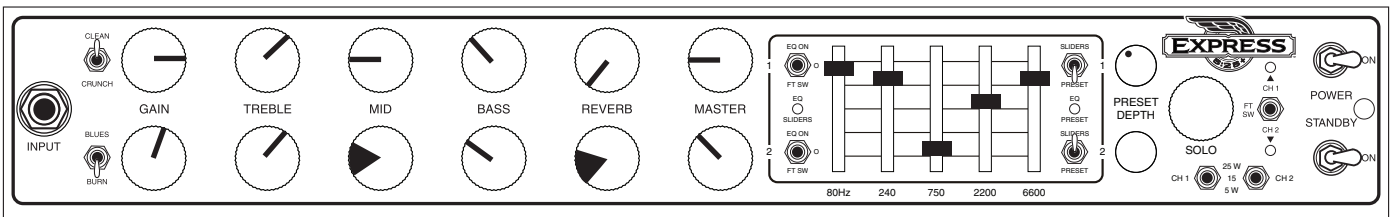

PERSONAL SETTINGS

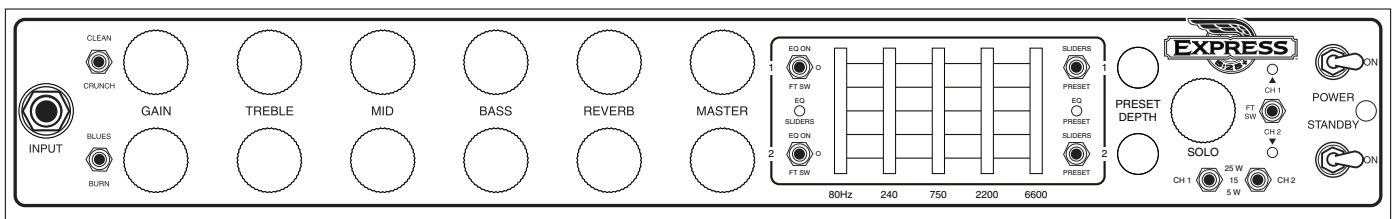
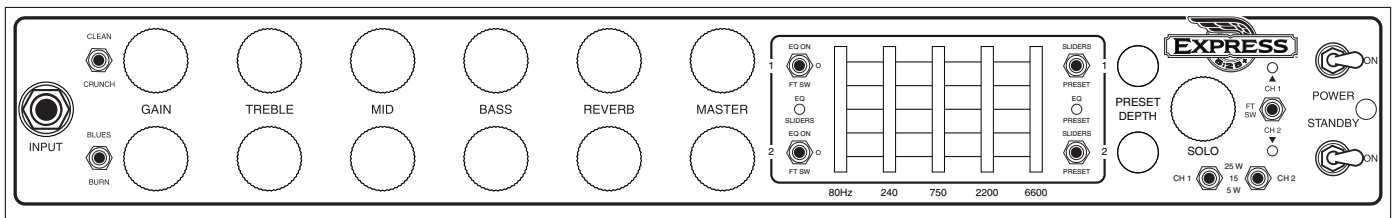
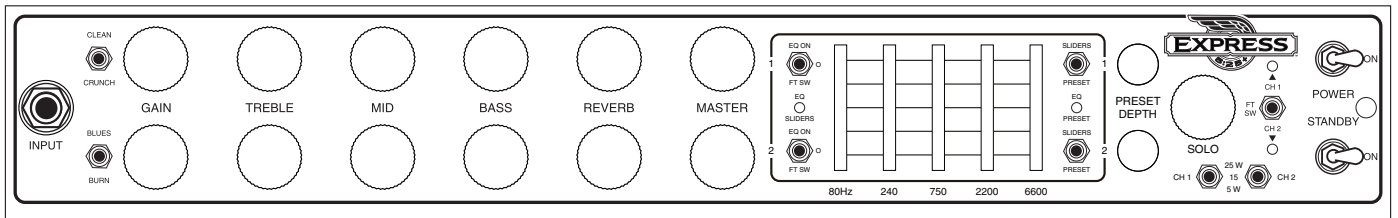
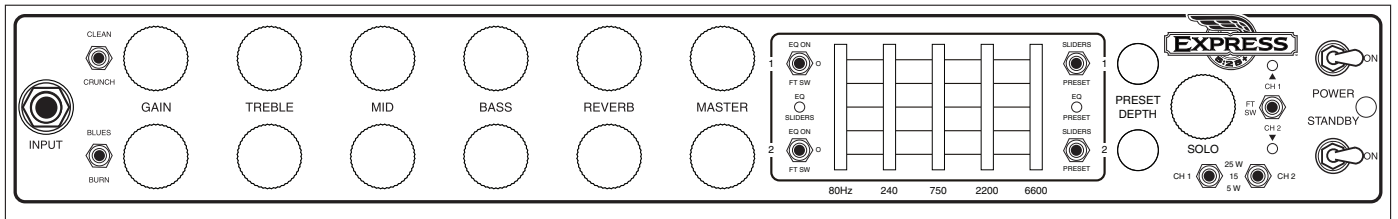
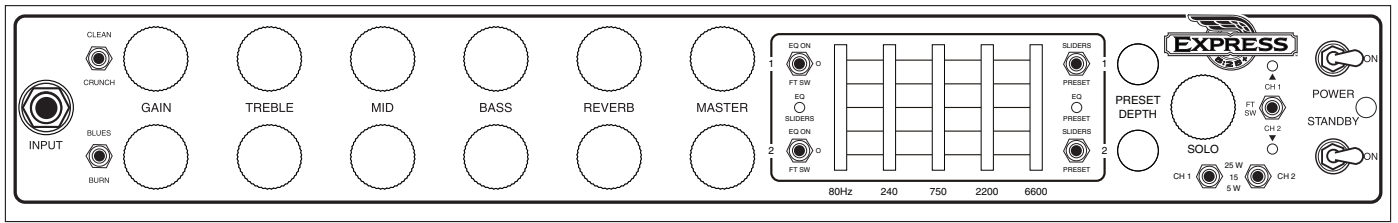

TUBE NOISE & MICROPHONICS:

You may occasionally experience some form of tube noise or microphonics. Certainly no cause for alarm, this quirky behavior comes with the territory and the Tone. Much like changing a light bulb, you don't need a technician to cure these types of minor user serviceable annoyances and in fact, you'll be amazed at how easy it is to cure tube problems...by simply swapping out a pre-amp or power tube!

First may we suggest that you set the amplifier up on something so that you can get to the tubes comfortably without having to bend down. It also helps to have adequate lighting as you will need to see the tube sockets clearly to swap tubes. **Use caution and common sense when touching the tubes after the amplifier has been on as they may be extremely hot!** If they are hot and you don't want to wait for them to cool off, try grasping them with a rag and also note that the glass down around the bulbous silvery tip is considerably less hot which makes it easier to handle. Gently rock the tube back and forth as you pull it away from its socket.

DIAGNOSING POWER TUBE FAILURE:

There are two main types of tube faults: shorts and noise. Both large and small tubes may fall prey to either of these problems but diagnosis and remedy is usually simple.

If a fuse blows, the problem is most likely a shorted power tube and shorts can either be mild or severe. In a mildly shorted tube the electron flow has overcome the control grid and excess current flows to the plate. You will usually hear the amp become distorted and begin to hum slightly. If this occurs, quickly look at the power tubes as you switch the amp to STANDBY and try to identify one as glowing red hot. It is likely that two of a pair will be glowing since the "shorted" tube will pull down the bias for its adjacent mates, but one tube may be glowing hotter — and that one is the culprit. The other two are often fine — unless they've been glowing bright red for several minutes.

Because there is no physical short inside the tube (just electrons rioting out of control) merely switching to STANDBY for a few moments then back to ON will usually cure the problem...at least temporarily. Watch the tubes carefully now. Should the problem recur, the intermittent tube will visibly start to over heat before the others and thus it can be identified. It should be replaced with one from the same color batch, shown on its label. Call us and we will send one out to you.

The severe short is not nearly so benign. In the worst cases, a major arcing short occurs between the plate and the cathode with visible lightning inside the glass and a major noise through the speaker. If this is seen to happen, IMMEDIATELY turn the amp to STANDBY. By this time the fuse probably will have blown. Such a short is usually caused by a physical breakdown inside the tube including contaminate coming loose or physical contact (or near contact) between the elements. Replace it and the fuse with the proper slo-blo type and power up the amp using the power up procedure as we described earlier in this manual.

TUBE NOISE:

Often caused by contamination within a tube, the culprit can usually be identified, and by lightly tapping on the glass, you will probably hear the noise change. Hearing some noise through the speakers while tapping on the 12AX7's is normal however. And the one nearer the INPUT will always sound louder because its output is being further amplified by the second 12AX7.

The power tubes should be all but quiet when they are tapped. If crackling or hissing changes with the tapping, you have probably found the problem. To confirm a noisy power tube, merely put the amplifier on Standby, remove it from its socket and turn it back on. It will cause no damage to run the amplifier briefly with one power tube missing. You may notice a slight background hum, however, as the push-pull becomes unbalanced. Whenever you are trying to diagnose a suspect tube, keep your other hand on the POWER and STANDBY switches ready to shut them off instantly in the unlikely case you provoke a major short.

If you think you've located a problem tube but aren't sure, we recommend substituting the suspect with a new one just to be sure of your diagnoses. You will be doing yourself and us a big favor by just following the simple guidelines previously mentioned regarding tube replacement. You'll probably be successful with much less effort than is required to disconnect everything and haul the unit to a technician who will basically perform the same simple tests. If the tubes are still within their six-month warranty period, we will happily send you a replacement. Just note the color designation on the tube label so that we can send you the appropriate match.

DIAGNOSING PRE-AMP TUBE PROBLEMS:

Because your amplifier is an all tube design, it is quite possible that you will at some point experience minor pre-amp tube noise. Rest assured - this is no cause for alarm and you can take care of the problem yourself in a matter of minutes by simply swapping tubes.

Let us begin by saying; It is a "very good" idea to keep at least a couple of spare pre-amp tubes on hand at all times to insure uninterrupted performance. These minor pre-amp tube problems can take many forms but can generally be described in two categories: Noise and Microphonics. Noise can be in the form of crackling, sputtering, white noise/hiss and/or hum. Microphonic problems usually appear in the form of a ringing or high pitched squealing that gets worse as the gain or volume is increased thus are more noticeable in the higher gain "HI" modes. Microphonic problems are easily identified because the problem is still present even with the instruments' volume off or unplugged altogether - unlike pick-up feedback which ceases as the instrument is turned down. Microphonic noise is caused by mechanical vibration and shock: think of banging a microphone around and you'll understand where the word came from.

The best way to approach a pre-amp tube problem is to see if it occurs only in one specific mode or channel. This should lead you to the tube needing replacement. Then all that remains is to swap the suspect tube for a known good performer. If you cannot narrow down the trouble to a specific mode or channel, the problem may be the small tube that drives the power tubes which is operational in all modes and channels. Though rare, a problem with the driver tube would show up in all aspects of performance - so if you can't narrow the problem down to being mode or channel specific, you may want to try replacing the driver tube. Driver problems generally show themselves in the form of crackling or hum in all modes of performance and/or weak overall output from the amplifier. Occasionally an anemic driver tube will cause the amplifier to sound flat and lifeless, but this is somewhat uncommon, as worn power tubes are a more likely suspect for this type of problem.

Sometimes making the diagnosis is more trouble than it's worth and it's faster and easier to merely replace the small pre-amp tubes ONE AT A TIME with a replacement known to be good. But MAKE SURE you keep returning the tubes to their original socket until you hit the one that cures the problem. You'll notice that tubes located nearer to the INPUT jack always sound noisier...but this is because they are at the start of the chain and their noise gets amplified over and over by the tubes that follow. The tube that goes into this "input socket" (usually labeled V1) needs to be the least noisy of the bunch. The tube that goes at the end of the preamp chain - just ahead of the power tubes - can be quite noisy without causing any problem at all. The tubes in your amp have already been located in the most appropriate sockets and this is why you should NEVER pull them all out at once and ALWAYS swap them one at a time. ALWAYS return a perfectly good tube to its original socket. Also it's a good idea to put the amp on STANDBY when swapping tubes to reduce the heat build up in the tubes themselves and to prevent explosive noises (which can still occur even if you are pulling the tubes away from their sockets gently) from coming through the speaker.

Remember, take your time, be patient and chances are real good that you can fix your amp yourself by finding and replacing the bad tube. It kills us to see someone who has shipped their amp back to us...and all it needed was a simple tube replacement! If you must send back your amp, remove the chassis from the cabinet by unscrewing the four mounting bolts on the bottom top. The chassis then slides back like a drawer and comes out from the back. Remove the big power tubes and mark them according to their location from left to right 1, 2 etc. They need to be wrapped separately with plenty of wadded up newspaper around them and put in a smaller box within the larger carton. Remove the Rectifier tubes and wrap them also. You can leave the preamp tubes in or remove them and wrap them separately being sure to label their location. (See Tube Task Chart.)

To wrap the chassis, use plenty of tightly wadded up newspaper so there is at least six inches of "crush space" between the chassis and the cardboard box. Bubble wrap also works well, but please DON'T use styrene peanuts - they will shift during transit and get lodged inside your electronics as well as allowing your amp to end up at the bottom of the box unprotected and possibly damaged.

Pre-amp tubes don't normally wear out as a rule. Therefore, it is not a good idea to change them just for the sake of changing them. If there isn't a problem - don't fix it. If there is no result from your substitutions, it may be possible that you have more than one problematic tube. Though rare, this does happen and though it makes the troubleshooting process a little more intimidating, it is still possible to cure the problem yourself.

NOTE: *It is normal to hear a slight metallic ringing sound when tapping on the preamp tubes. As long as the tube does not break into oscillation or start crackling or any other form of bizarre noise, it is considered normal and functional.*

BIAS ADJUSTMENT: (Part of a continuing series)

An Article written by Randall Smith that we thought you might find interesting.

Here's a question we often hear:

"Why doesn't *Mesa* put bias adjustments in their amplifiers?"

Well, there's a short answer and a long answer to this question.

The short answer is that during my 12 years of repairing Fenders, one of the most frequent problems I saw was bias controls that were either set wrong or that had wandered out of adjustment due to vibration. As any honest tech will tell you, there's lot's of easy money to be made by sprinkling "holy water" on amplifiers ... uh, what I meant to say is "Your amp needed biasing." See what I mean? What customer is going to argue with that?

It only takes a moment and a volt meter: The Fender diagram shows how: "Adjust this trim pot for - 52 volts." That's it. Nothing more.

Now don't be fooled into thinking that tubes "draw" more or less bias, they don't. The way a bias supply is connected to a tube is akin to a dead end road, it just trails off to nowhere without really completing a circuit. It's a static voltage and regardless of what tube is in the socket — or even if the tubes aren't plugged in at all, it doesn't change the bias voltage a bit.

So the end of the short answer is this: Since a bias supply needs to put out the right voltage and never vary, I wanted to build amplifiers that were individually hard wired to the correct values and NEVER needed adjustment. And for 25 years, that's how *MESA/Boogies* have been built.

Time to change tubes? Just plug our tubes into any one of our amps and you're DONE. No tech needed. NO bills and no BS about biasing. And most important: The bias is RIGHT because it can't change!

Now, you want the long answer? Here's more information on how our hard-wired bias avoids trouble. Please read on.

But first, let's make an important distinction. Our business is designing and building high performance amplifiers. And for this we need tubes whose variance is within a narrow range. Our warehouse is full of rejects ...oh, they work — they just don't perform within our tolerance range. We have a very sophisticated computer - based tube testing system (nicknamed "Robotube") that matches and measures tubes over seven important parameters. It can even predict which tubes are likely to have a shortened lifetime — even though they work perfectly during the test.

Because our business is building quality amps, we can afford to reject a lot of wayward tubes. The guys you hear complaining because *Boogies* don't have bias adjusters are primarily in the business of selling tubes - not amps. They don't want to throw away 30 percent of their inventory, so they promote the idea that tubes outside our parameters can be used to "customize" amplifiers and they criticize us because our amps can't be adjusted to accommodate their out-of-*MESA* tolerance tubes.

Now you might be thinking, "But I thought you just said that tubes don't "draw" bias, therefore they don't effect the bias supply and thus it doesn't need to be adjustable." When you set the bias (whether it's by selecting the right resistors, as we do, or adjusting a trimmer — which is quicker) what you are doing is establishing the correct amount of idle CURRENT that flows through the power tubes. But you can't adjust the current directly, you can only change it by adjusting the amount of bias VOLTAGE that goes onto the tubes'

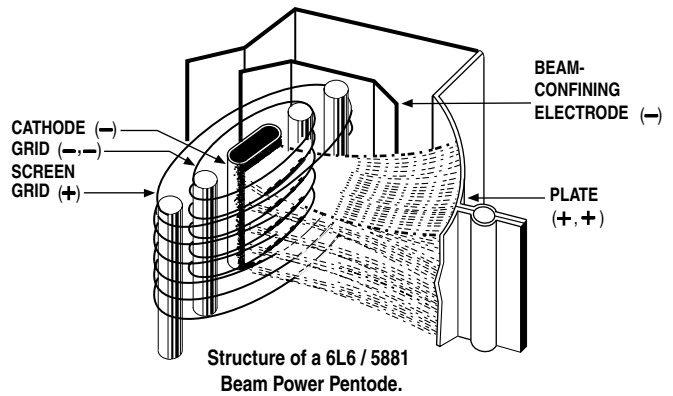

BIAS ADJUSTMENT: *(Continued)* control grids. Voltage and current are NOT the same. Current is the AMOUNT of electricity, the “quantity” — and is measured in amperes. Voltage is the degree of electric charge — like the “pressure” to use the old water analogy. Let me illustrate how different voltage and current are:

When you scrape your feet across a carpeted floor in dry, wintery conditions, your body can become charged with 50,000 to 100,000 volts of static electricity. And when you reach for the door knob, a spark jumps and you feel it! The voltage is super high but the current (measured in micro-amps) is tiny - otherwise you would die from electrocution.

Contrast this with your car battery, which puts out a mere 12 volts. You can lay your hands right across the terminals and not feel a thing. Yet the amount of current available can run to several hundred amperes .. enough to turn over a cold engine and get it started.

So current and voltage are two totally separate electrical parameters — though when you multiply them together, you get POWER, which is measured in watts.

When you set the bias of an amplifier, you are adjusting the static VOLTAGE at the control grid of the tube in order to produce a desired amount of idle CURRENT flowing to the tube’s plate. A small change in grid voltage, produces a large change in the amount of current flowing — and that’s basically how a tube works. Say that again because it’s super important: A small change in voltage at the grid causes a large change in current flowing to the plate. See, that’s the essence of amplification: A small change causing a large change. And here it’s a small voltage change causing a large current change.

The bias conditions are what determines how much current flows through the big power tubes when you’re not playing. And what drives your speakers is fluctuations in that current flow when you ARE playing. If the amount of current increases and decreases 440 times per second, then you’ll hear an A note. If the fluctuations in current flow are large and still at 440 per second, you’ll hear an A that is LOUD!

But for purposes of biasing, it’s the amount of “plate current” flowing with no signal applied that’s important. Unfortunately current is hard to measure because the circuit must be interrupted — as in “cut the wire” — and the meter spliced “in series” with the broken circuit. But measuring VOLTAGE is easy. It is not necessary to interrupt the circuit because a voltage reading can be taken in PARALLEL with the circuit intact.

Thus, as a matter of convenience, most bias settings are given in volts at the grid ... even though current through the plate is the important factor. In fact plate current is so inconvenient (and dangerous) to measure that Fender doesn’t even state what the correct value should be. They only give the grid voltage that will produce that current. (That’s the minus 52.) But that only happens if the tubes being used are “in spec.”

As long as the tubes ARE “in spec”, the right bias voltage will always give the correct plate “CURRENT” — but then there’s no need for the bias voltage to be adjustable!

If the tubes are NOT in spec, then the only proper way to re-set the bias is to cut the circuit and measure the current while adjusting the bias ... but no manufacturer I know even STATES the desired current value! Be that as it may, when the original bias voltage is altered far enough, it will compensate for the tube’s abnormal performance and the correct amount of idle current flow may then be restored. Clearly this is something most repair techs should not attempt.

Some newer amps have LED indicators connected to the circuit which will turn on when the right threshold of current flow has been reached. This is an improvement, and almost worthy if you’re willing to accept resistors and lights added into your amplifier’s audio path — which we aren’t.

The other “advantage” of this system is that it allows some amp manufacturers to avoid matching their power tubes. The thinking is that adjusting the bias to each tube separately eradicates the inherent differences between the tubes by insuring that the same current flows through each one.

BIAS ADJUSTMENT: *(Continued)* Again, this has some merit .. but it's still not as good as using tubes that are matched in the first place because compensating for the mis-match causes the push-pull circuit itself to become unbalanced. Two wrongs don't really make a right.

Some of the other recommended biasing, "methods" — such as -".. tubes running red hot, increase the bias .. sounds harsh and runs too cool, turn it down ..." are guesswork at best. Luckily, one of the great things about tube amps is that they can usually stand some abuse without causing any real harm ... at least not immediately. But don't these alterations imply that you are second-guessing the amp designer and that there's a better set of operating conditions that the designer missed but the tube sellers have discovered?

Now some players may like the sound of their amp altered by tubes with extreme characteristics and with the bias set to help compensate. But often it is the mere novelty of change that they're really responding to and when the amp goes back to the proper original way, we've seen them be far happier still!

Because every part in every one of our designs has been meticulously evaluated, compared and stressed over — no matter how seemingly insignificant it might be. And with every design we look for a "sweet spot" where all the parameters — including the bias — come together to give the best sonic performance, consistently and reliably. Every part and voltage is important — yet no one complains that these other parameters aren't available for tinkering.

Consider our patented *Simul-Class* circuitry where there are two different bias voltages used for separate pairs of power tubes ... and changing one voltage also changes the other. Great care goes into getting this just right and we think we'd be asking for trouble to have it adjustable for the world to play with ... unless you like paying to have your amp messed up. Sorry, I meant to say, "Uh, ... your amp needed biasing."

If that doesn't appeal to you, then merely plug a matched set of *MESA* tubes into one of our amps and you're ready for tone. Guaranteed. You'd be amazed at the number of service calls we field every day that lead to a diagnosis of out-of-tolerance, non-spec tube problems. To think these would be prevented by including a bias adjustment is something of an insult to you and us. If you put the wrong size tires on your car, do you think changing the pressure will make them right?

Please, don't think this is a blanket indictment of the other guys selling tubes — it isn't. And their tubes aren't all bad either. It just doesn't make sense to pay more of your hard earned cash for tubes that were probably made in the same Russian or Chinese factory and which have the possibility of being outside the performance window we select for your amp. And it pains us to hear the hype and mystique built up around biasing when twenty-five years of evidence affirms our decision to make bias circuits that "never need adjustment". How much money and trouble that has saved *MESA/Boogie* players you couldn't estimate.

Our rigorously tested and hand selected tubes are available at your nearest *MESA/Boogie* Pro Center or from us directly. Nobody offers better price, quality or warranty than we do ... so why swerve?

Next time we'll talk about our part in developing the great Sylvania STR 415 type 6L6 and how we're on the verge of seeing something fairly close reappear on the market. Remember, we still have some of these super rugged mondo-bottles available for older amps — *Boogies* only please! Until then, Relax, Breathe and Nourish your soul!

Cheers!

MESA/Boogie Ltd.

SPEAKER IMPEDANCE MATCHING & HOOK-UP GUIDE:

IMPEDANCE: Wiring up speakers to provide the most effective load and making sure that all of them are in phase will help in creating the best sound possible. This is not too difficult, as long as you understand a few things about loading and how to connect your speakers to provide an optimal resistive load.

MESA/Boogie amplifiers can handle 4 and 8 ohms effectively. Never run below 4 ohms in a tube amplifier unless you are absolutely certain that the system can handle it properly; this can cause damage to the Output transformer. A few amplifiers can handle 2 ohms effectively without damaging them (for example the *MESA'S Bass 400+*). You can always have a higher resistance (16 ohms, for example) without damaging results, but too low of a resistance will likely cause problems.

MIS-MATCHING: When running a higher resistance (for example: 8 ohm output into 16 ohm cabinet), a slightly different feel and response will be eminent. A slight mismatch can provide a darker smoother tone with a little less output and attack. This response is a result of the amplifier running a bit cooler. Sometimes when using more than one cabinet a mismatch will be the only option.

WHAT IS MY CABINETS IMPEDANCE: If you have only a single speaker, you just match that single speakers impedance to the amplifier, and you are done. In many cases, you will have a number of speakers, and then you must calculate the "load" that the amplifier will need to support. There are generally three ways to wire multiple speakers together. They are as follows:

SERIES: When you wire (hook-up) speakers in Series, the speakers resistance (as measured in ohms) is additive - i.e. putting two 8 ohm speakers in Series results in a 16 ohm load.

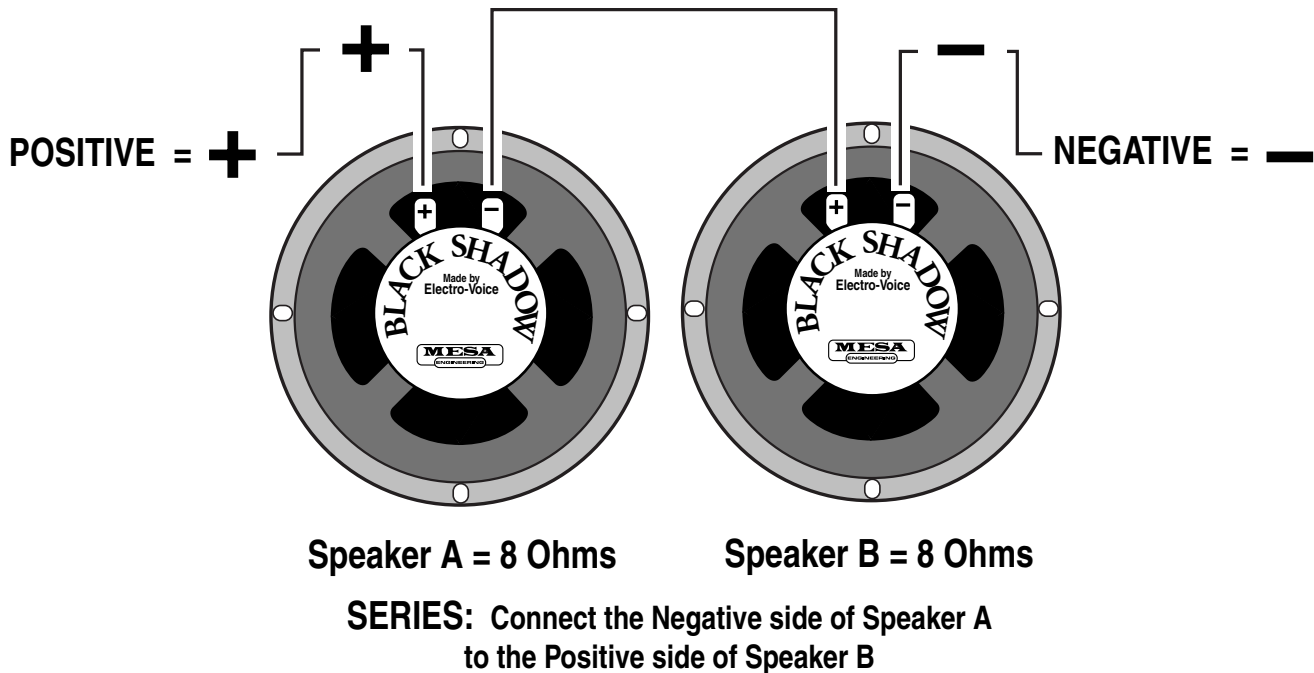

SPEAKER IMPEDANCE MATCHING & HOOK-UP GUIDE: (Continued)

PARALLEL: When wiring in parallel, the resistance of the speakers decreases. Two 8 ohm speakers wired in (hooked-up) Parallel results in a 4 ohm load. It's easy to calculate the effect of a resistive load when all the speakers are all the same resistance. It is really not suggested to wire different resistive load values in Parallel (8 and 4, 16 and 8 etc.) The formula for figuring the total impedance in Parallel is the multiplication of the two loads divided by the sum of the two loads - i.e. putting two 8 ohm speakers in Parallel results in a 4 ohm load. Connect the Positive side of Speaker A to the Positive side of Speaker B - Connect the Negative side of Speaker A to the Negative side of Speaker B.

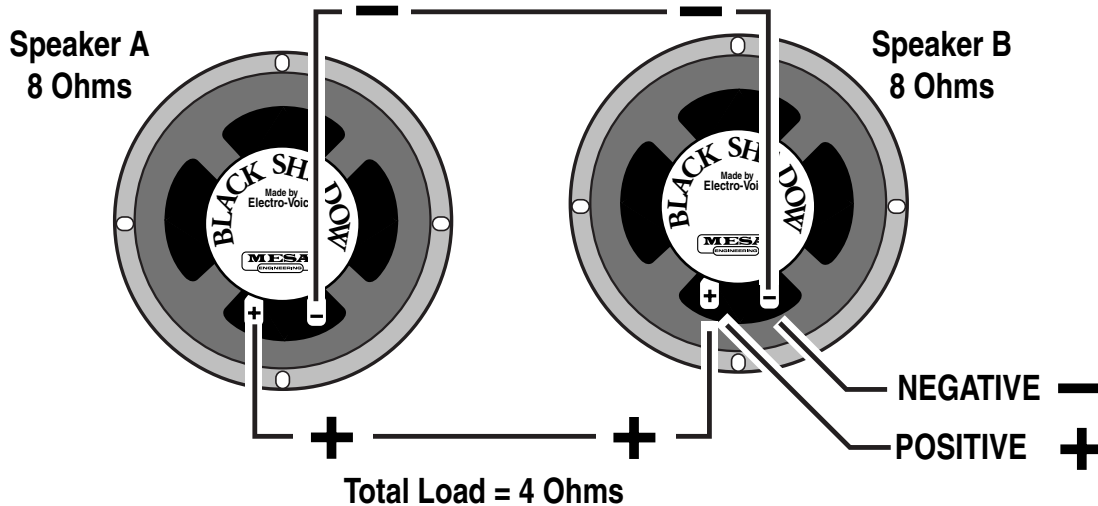

COMBINATION OF SERIES & PARALLEL: This is really just two sets of Series wired speakers connected in Parallel. This is how you maintain a consistent load with multiple speakers. The importance of this is more evident when you have more than one cabinet to connect to your amplifier. This is when you need to figure out the loads and how to wire them up without applying too low of a resistance on the amplifier.

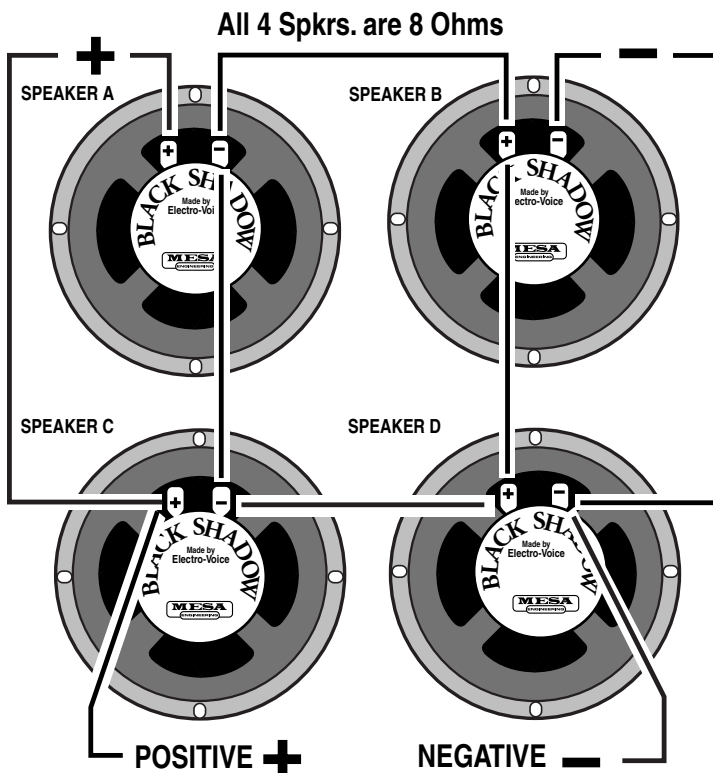

Simply connect the Positive side of Speaker A to the Positive side of Speaker C.

Connect the Negative side of Speaker A to the Positive side of Speaker B. Next, connect the Negative side of Speaker C to the Positive side of Speaker D.

And lastly, connect the Negative side of Speaker B to the Negative side of Speaker D.

4 Eight (8) Ohm speakers wired in Series Parallel = a Total Load of 8 Ohms.

WIRING SCHEMES...Amplifier to Speaker Cabinets

1

2

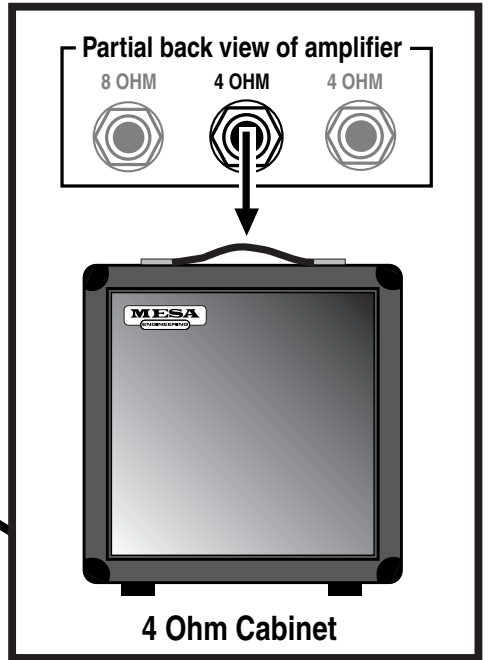
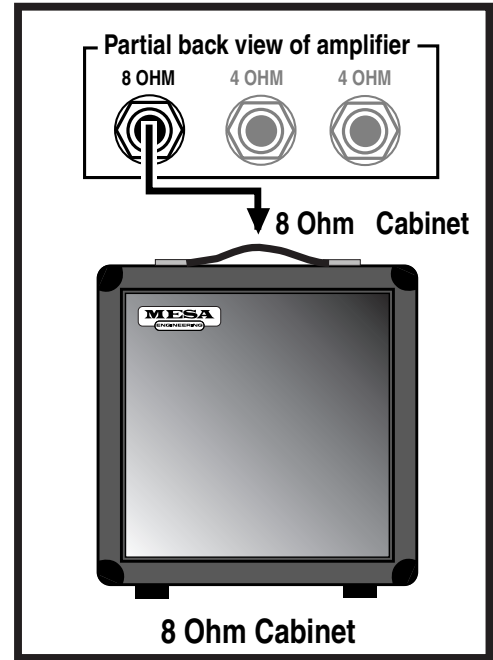

3

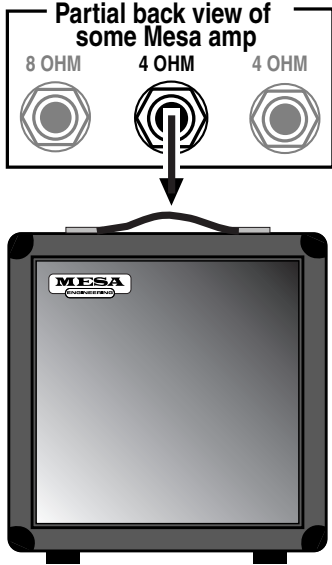

4

5

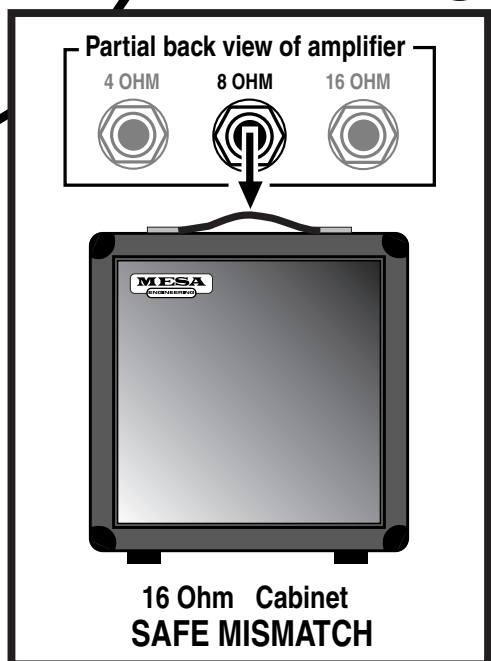
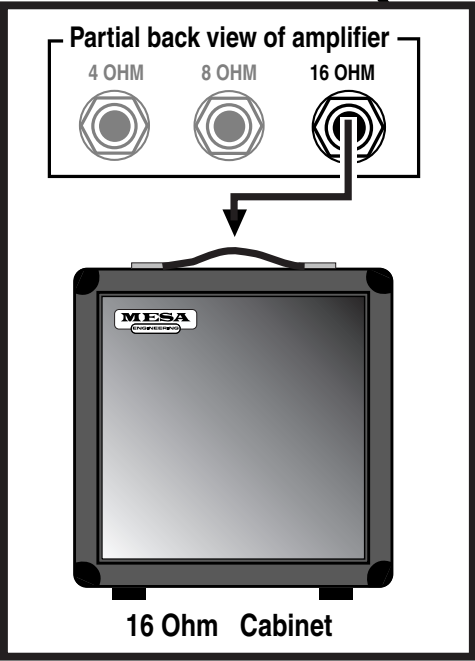

WIRING SCHEMES...Amplifier to Speaker Cabinets

6

7

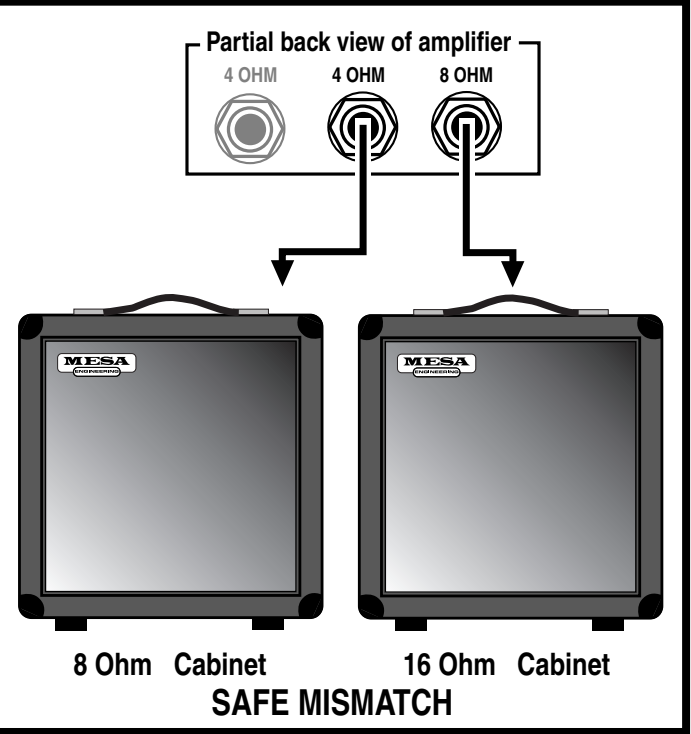
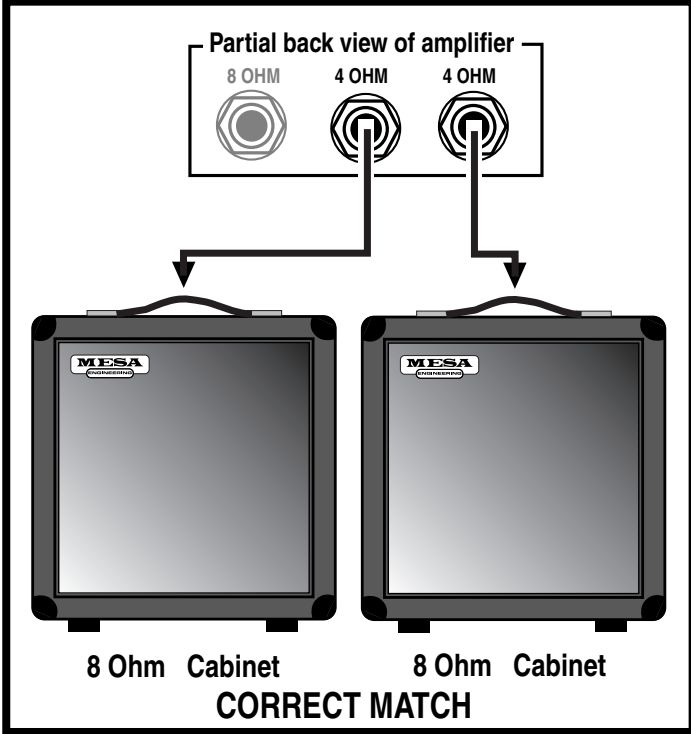

8

9

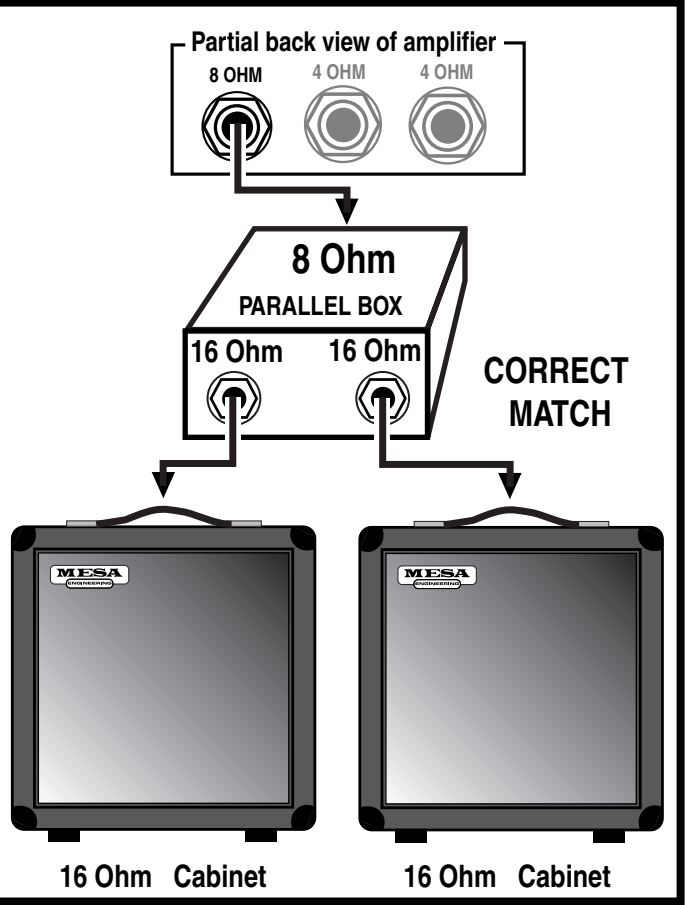
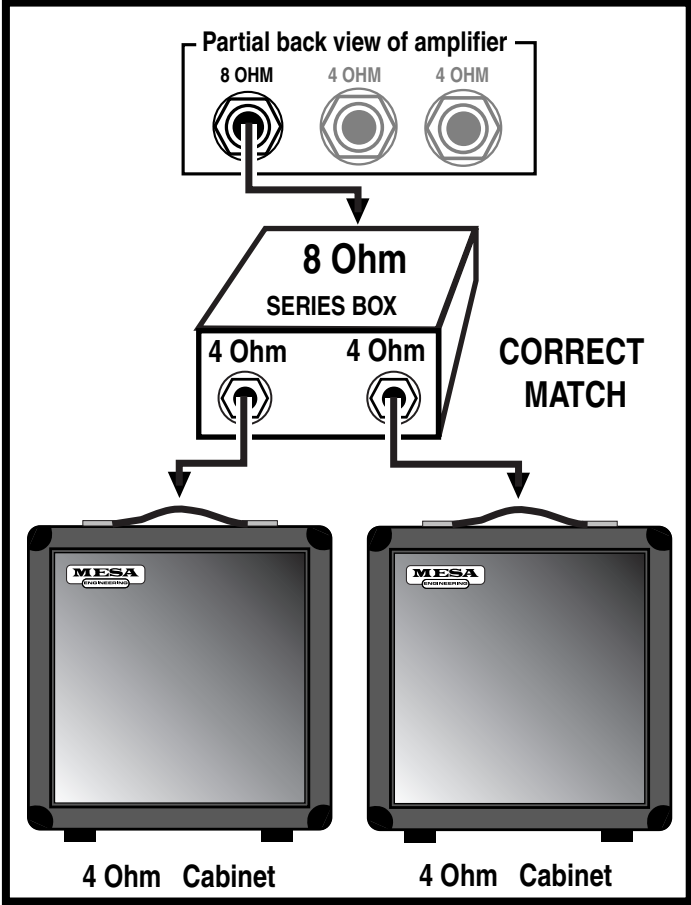

WIRING SCHEMES...Amplifier to Speaker Cabinets

10

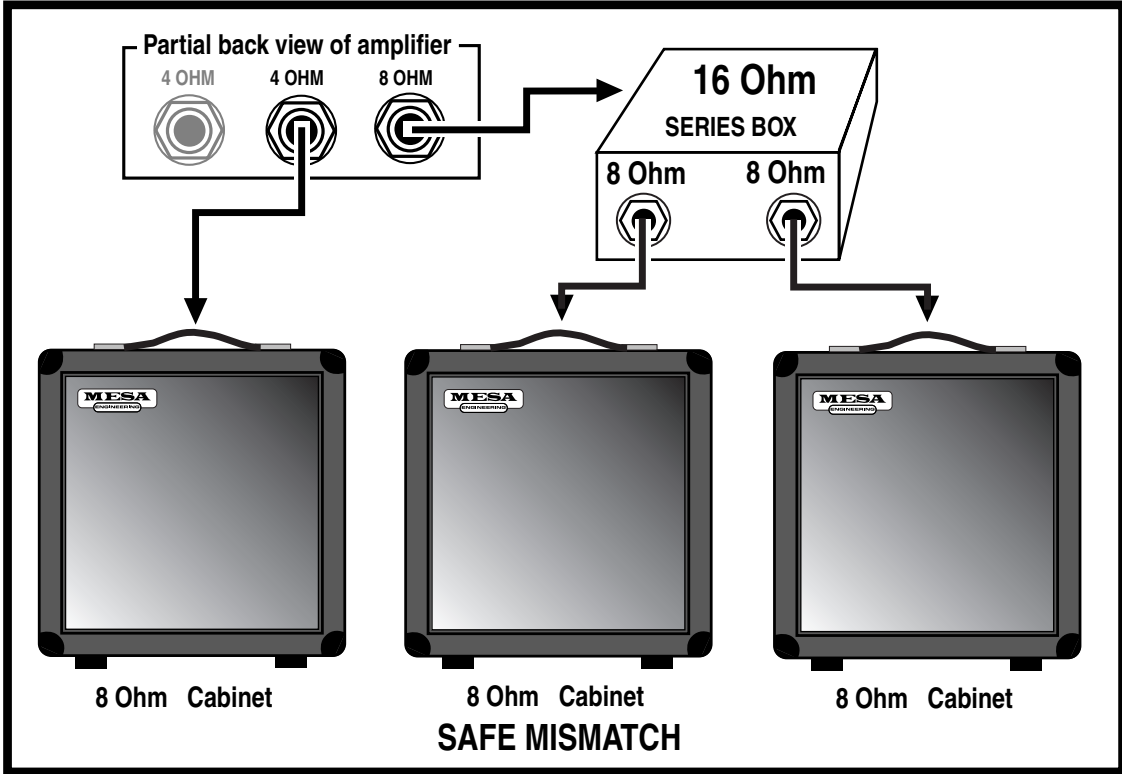

11

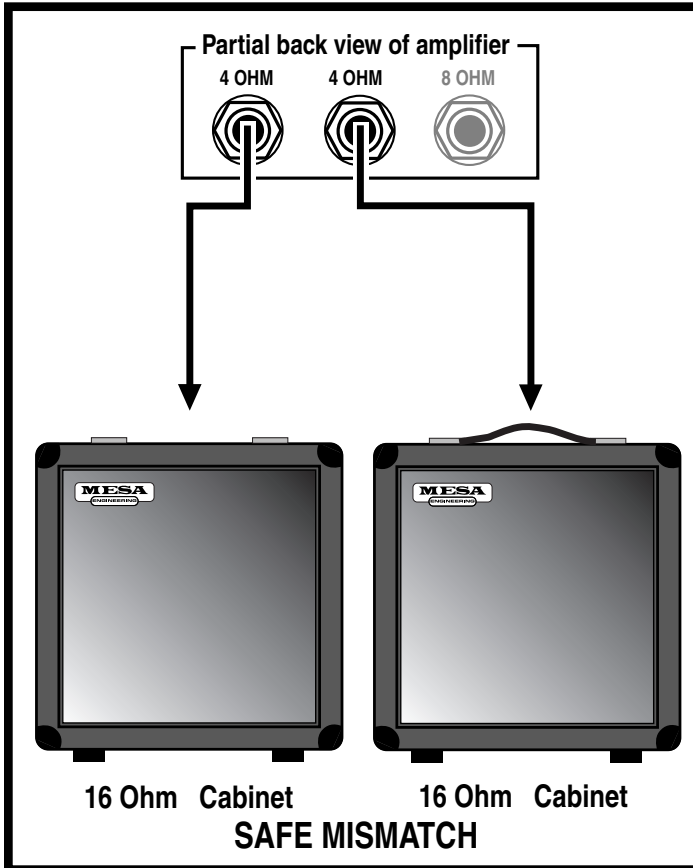

12

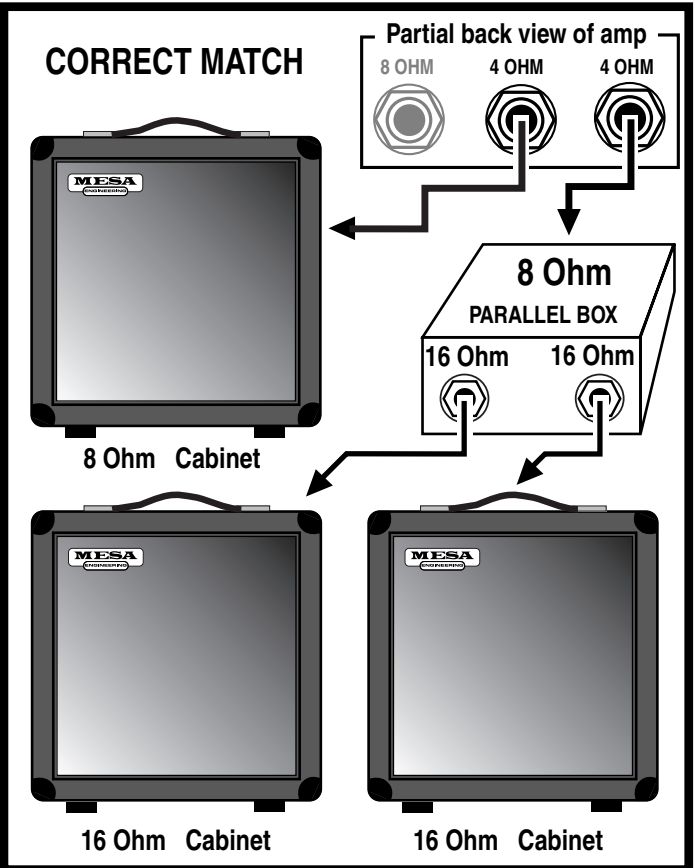

WIRING SCHEMES...Amplifier to Speaker Cabinets

13

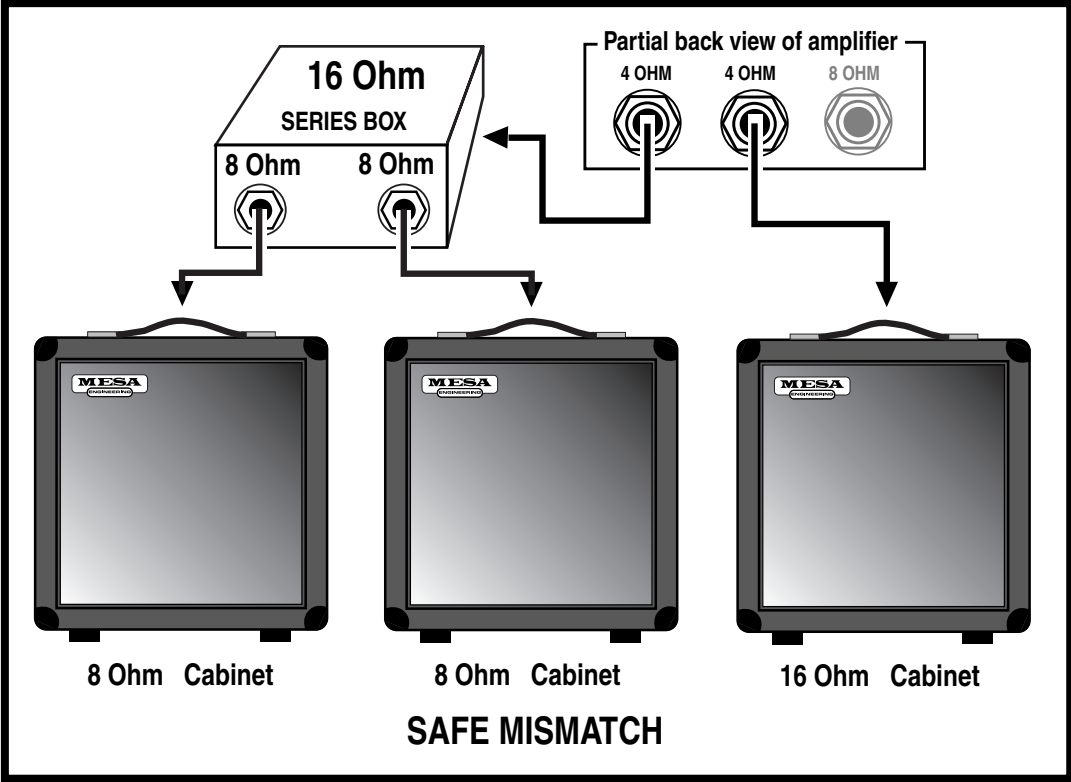

14

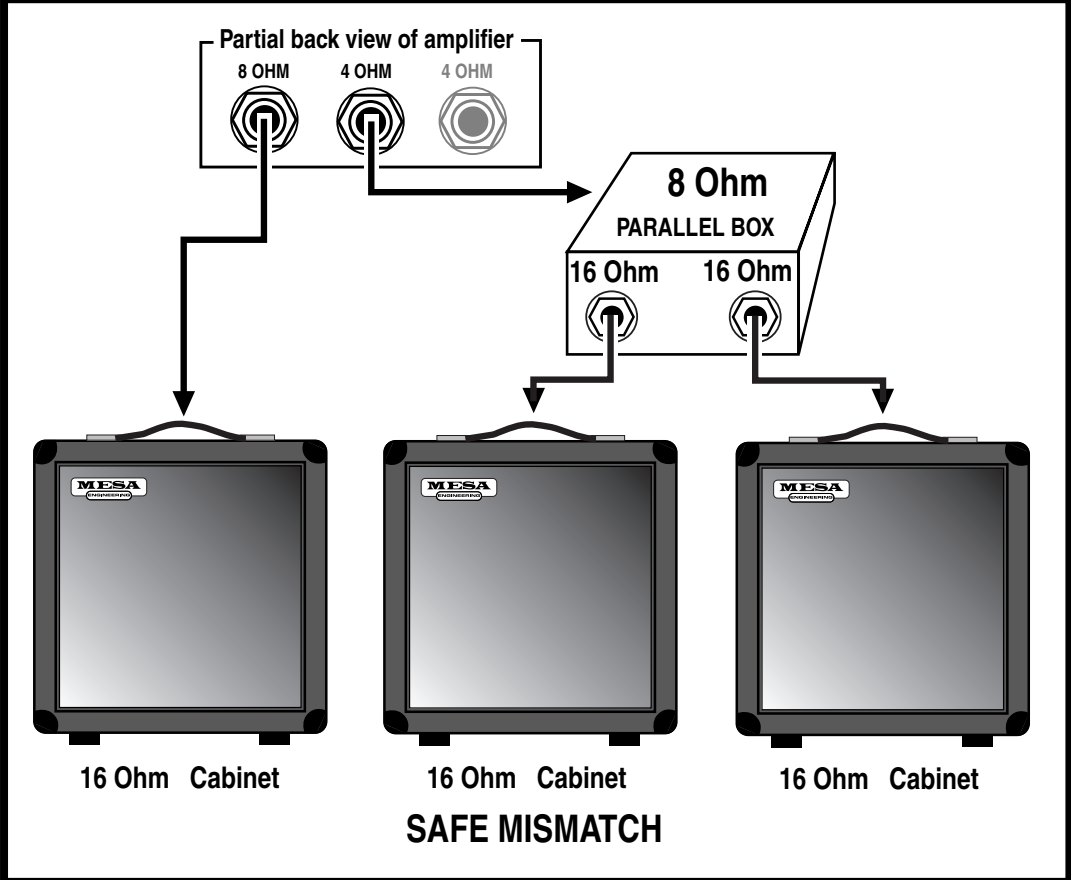

ON TRIODES, PENTODES & IRISHMEN:

With apologies to Friends and Relatives from the Emerald Isle - who will make their appearance soon enough - the humor which follows is dedicated to the memories of Spec McAuliff and Fae (Rafael) McNally, two of the True Greats.

As their numerical references suggest, the terms Diode, Triode and Pentode indicate the number of elements within the vacuum tube i.e. two, three or five. All tubes also require a filament or heater which is not included in the count. Its purpose is to excite electrons from the cathode coating by raising the temperature such that they are able to boil out of the electron-rich coating material and form a cloud of free electrons in the vacuum space surrounding the cathode.

Although the term filament and heater are often used interchangeably, there are specific differences: A filament is a directly heated cathode where cathode coating is applied directly to the heating element. Examples are 5U4 twin diode rectifier and 300B triode amplifier tubes. A heater, on the other hand, is a heating element which is separate from the cathode and is usually inserted within the tubular cathode sleeve. Examples are 12AX7 twin triode amplifier and 6V6 or EL84 beam power pentode tubes. In all cases this fundamental aspect of each tube's construction is clearly visible, especially when the heating element is glowing red hot.

The cathode, then, would be considered the first numbered element because it is the source of the electrons. The word itself is from the Greek literally meaning completely down, which implies a sense of central origin - like the center of the earth where Tone begins. It might be said that an ecstatic audiophile experiences a positive catharsis, his soul being purified when his system transports him to Audio Nirvana. The only trouble with taking this positive imagery too far is that the cathode is, unfortunately, negative... at least electrically speaking. However this is easily remembered since virtually all musicians and audiophiles have also experienced the more common negative catharsis when they emerge from the emotional rebirth kicking and screaming in rage and frustration.

Once heated, the intrinsically negative electrons are energetic little fellows of almost no mass. Thus they may be accelerated almost instantaneously and will travel through a vacuum a nearly the speed of light. Being of like, negative charge, they tend to repel one another and thus within the electron cloud surrounding the cathode, there is much jostling and elbowing as each one tries to maintain his distance from all the others... unless there is a strong and universal attraction from an outside influence.

Visualize, if you will, a group of sub-atomic Irishmen milling about and in a repellent, negative state of mind. All are scowling and none wants to have anything to do with the other. Now introduce a strong attraction say, a public bar, and you can easily picture an orderly, if rapid movement of the lot in a single direction. This is what happens when a positively charged element called the anode or plate is introduced into the vacuum.

The plate is the large metal element most prominently visible through the glass of an electron tube. It is the outermost element of a tube's structure and it surrounds all the others. The cathode is at the center radiating electrons outwards. As higher and higher positive voltage is applied to the plate, the attraction for the electrons surrounding the cathode is increased and with nothing standing in the way, full uninhibited flow to the plate occurs... sort of like removing the doors and offering free drinks to the crowd of surly Irishmen milling around outside. As electrons flow to the plate, the space charge will continually be replenished by further 'boiling' of the hot, electron-rich cathode as you can easily imagine other Irishmen impatiently taking up the places of those who've gone inside - until the entire village is deserted.

Now, where do they come from and how do they emerge? Well, a grand and elegant lady once showed me how to revive flat champagne: She dropped a raisin into the glass. There was a dramatic and immediate increase in effervescence with the introduction of a cathoding surface. Thousands of tiny bubbles suddenly appeared - and continued to flow from the raisin. Of course the bubbles were made up of gas dissolved in the beverage, but the analogy makes it easy to visualize the loosely bound electrons dissolved in the rich cathode coating as they effervesce from its heated surface.

But back to the electron flow. If the electrons are strongly attracted to a positively charged plate, then it follows that they are strongly repelled by a negatively charged plate and they are. Thus, if an alternating current - such as comes from a transformer - is applied to the plate, electrons will flow only during the times when the plate is positively charged. During periods of negative plate charge, electron flow is stopped and the space charge of electrons remains compressed in the area around the cathode.

ON TRIODES, PENTODES & IRISHMEN: (Continued)

Thus a diode tube - one with a cathode and an anode - is mostly used to rectify alternating current into direct current by passing it without restriction, but in one direction only. This also explains why closing time is strictly enforced at Irish pubs: During normal operation, the traffic flow is similarly unimpeded and unidirectional toward the bar and this process rectifies the work-day negativity. It goes without saying that no one leaves as long as the atmosphere around the bar remains positively charged.

TRIODES:

This section is a continuing technical treatise on the workings of Irish Pubs but to make it easier for the layman to understand, it is explained in terms of vacuum tube technology. Enter the original bar - free beer and no doors. Well, it turns out that some control over the flow can be a necessary and useful advantage. This led to the invention of those swinging louvered saloon doors which are open at the top and bottom. They are patterned after the control grid of the vacuum tube, which is a loosely wound coil of thin wire located between the cathode and the plate.

In a Triode the plate is always positively charged with high voltage D.C. and even though the grid is blocking the path, those negative electrons can still FEEL the strong attraction - just as the Irishmen can see in through the louvers of the bar doors. They know what pleasures lie beyond, but to get there requires overcoming the negative influences controlling the access. This negative influence is typically called a Bias. In electronic terms that means the grid is supplied with a voltage which is slightly MORE NEGATIVE than the already negative electrons. The more negative the Bias, the more it tends to neutralize the attraction of the plate and repel the electrons back toward the cathode.

The Irish can be similarly charged with Bias, but unless you are Irish yourself, this type of Biasing may be more difficult to understand. The effect is similar though: The more negative the Bias, the more it impedes forward progress. Generally speaking though, the electronic Bias of the grid is easiest to overcome, and for two main reasons: First, the Bias is set - like the bar doors - to allow some passage. Second, the grid is mostly NOT THERE, like the louvered doors which are mostly open spaces. Unlike the plate which is solid, the grid is like a coiled bed spring. It can create a repelling field but mostly it's empty space in between widely separated windings of wire. It's very easy to control the electrons as they pass through the grid's force field: Changing the grid voltage only slightly will have an enormous effect on how much current flows through... and that's what AMPLIFICATION is: a small change in voltage at the grid causing a large change in current flowing to the plate.

The purpose of the louvered bar doors is similar to that of the grid, namely, to give momentary pause while still revealing the promise within. Hesitation mostly gives way to temptation, but there are those few stalwart Irishmen who think twice and decide to come back later. Most just pause slightly then go on through. That is the purpose of the bar doors: to prevent everyone from crowding in all at once - and as the door is made less of a barrier, wider spaces between the louvers, more of the bar's attractive influence is felt outside thus amplifying the customer flow and increasing the crowd at the bar.

PENTODES:

Occasionally though, bar doors - even the louvered type - were found to be too effective, and too many customers turned away. Something further was needed to increase the attraction of the bar and overcome the resistance created by the door. Thus the cocktail waitress was invented.

Once again the idea was inspired by the vacuum tube. It had been discovered in some tubes, often large power types, that the distance to the plate was too great to attract enough electrons past the negative influence of the control grid. So another grid coil of fine wire was inserted between the first grid and the plate. This was called the screen grid and carrying a highly positive charge, it functioned as a "bait" for the plate.

In a properly designed power tube such as an EL84 or a 6V6, the windings of the screen grid are precisely aligned to fall in the shadow of the control grid. This way the electrons responding to the pull of the screen grid are lined up in sheets as they pass between windings of the inner control grid... only to find that they have been fooled! Once past the control grid and drawn toward the screen grid, they discover...there's almost nothing there. The path they're on has them aligned to zing straight through the spaces BETWEEN screen grid windings. So rather than a close and personal encounter, they just fly on past - and once they're out that far, there's no stopping them. The influence of the plate takes over and - being solid metal and of the highest positive attraction - it is at this final destination that the electrons congregate.

PENTODES: *(Continued)* Thus the proper cocktail waitress - visible through the louvers - is scantily clad so as to be all the more effective at reinforcing the attractive influence of her bar and by being located in between the door and the bar, she serves as bait to lure customers past the door's negative influence. Once through the door however, it is the rare Irishman who actually comes in personal contact with the cocktail waitress as, for all intents and purposes, she - like the screen grid - turns out to be a vanishing illusion. Yet, having come this far, the solid influence of the bar itself now takes over and attracts the customers to congregate, having happily reached their destination.

If you're still following this and haven't lost track of the count, you'll know we're still one element short of the five needed to make a Pentode. This last part is a pair of beam-confining shields which being negatively charged, serve to direct the flow right toward the plate. This is much the way a short entrance hall to the bar prevents wandering accidentally into the Men's room on the way.

Once at the bar though, the circuit is complete and the process of soul-nourishing works its ritual magic. Biases having been overcome, illusory nightingales having vanished, the spirits truly soar and the once surly Irishmen now are filled with warmth, wit and kindred friendship, enjoying the music and glowing nicely with their heaters on.

With appreciative thanks to the inhabitants of the Land of the Leprechaun, we have now concluded our little diversion into the mechanics of proper bar lay-out.

A feature article by Randall Smith
Designer / President

BEFORE CHANGING TUBES FLIP POWER & STANDBY SWITCH TO OFF

Express 5:25 + HEAD & COMBO

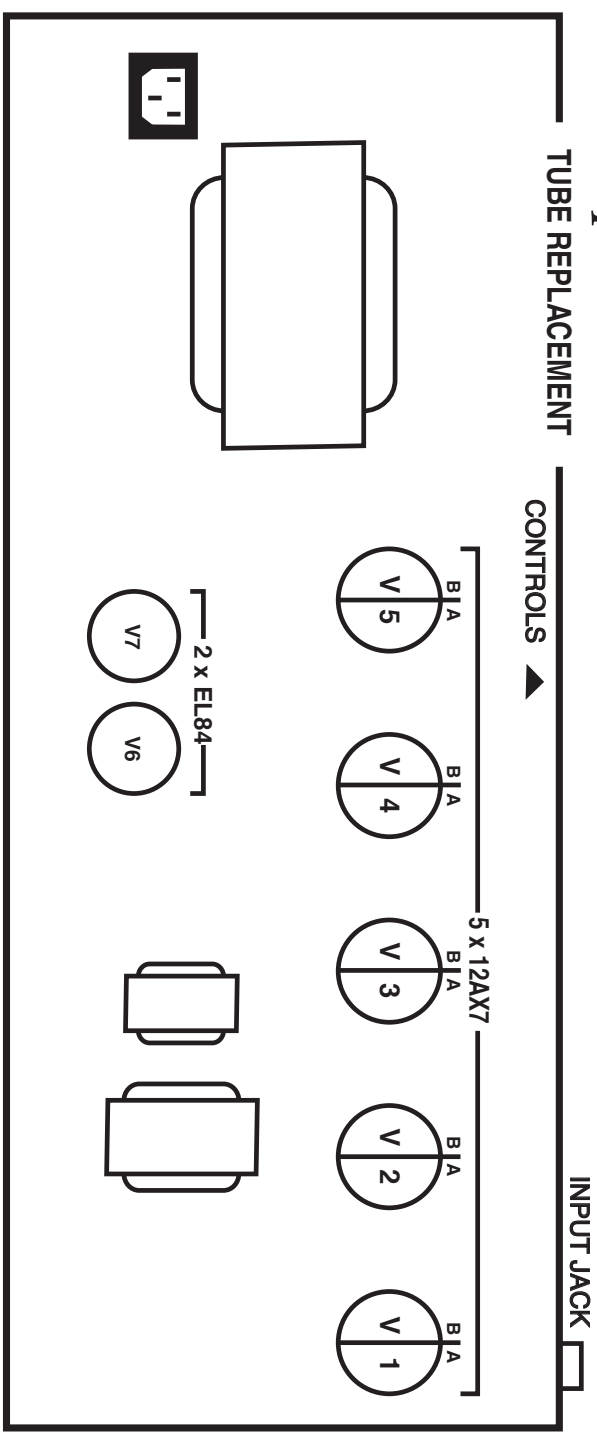

PREAMP TUBES		POWER TUBES	
V1A- 3rd Gain Stage CH 2	V3A- 3rd Stage Clean, 4th Stage Crunch, Blues & Burn	5 Watts = V7	
V1B- 2nd Stage Clean 3rd Stage Crunch	V3B- FX Return Stage	15 Watts = V6, V7	
V2A- Input Stage Crunch, Blues & Burn	V4A&B- Driver	25 Watts = V6, V7	
V2B- 2nd Stage Crunch, Blues & Burn, Input Stage Clean	V5A- Reverb Return		
	V5B- Reverb Send		

TO MAINTAIN WARRANTY, USE MESA/BOOGIE TUBES WHEN REPLACEMENT IS NECESSARY
 FOR CUSTOMER SUPPORT, PLEASE CALL 707-778-6565 MONDAY-THURSDAY 9-5 PST, OR EMAIL US AT INFO@MESABOOGIE.COM

BEFORE CHANGING TUBES FLIP POWER & STANDBY SWITCH TO OFF

Express 5:50 + HEAD AND COMBO

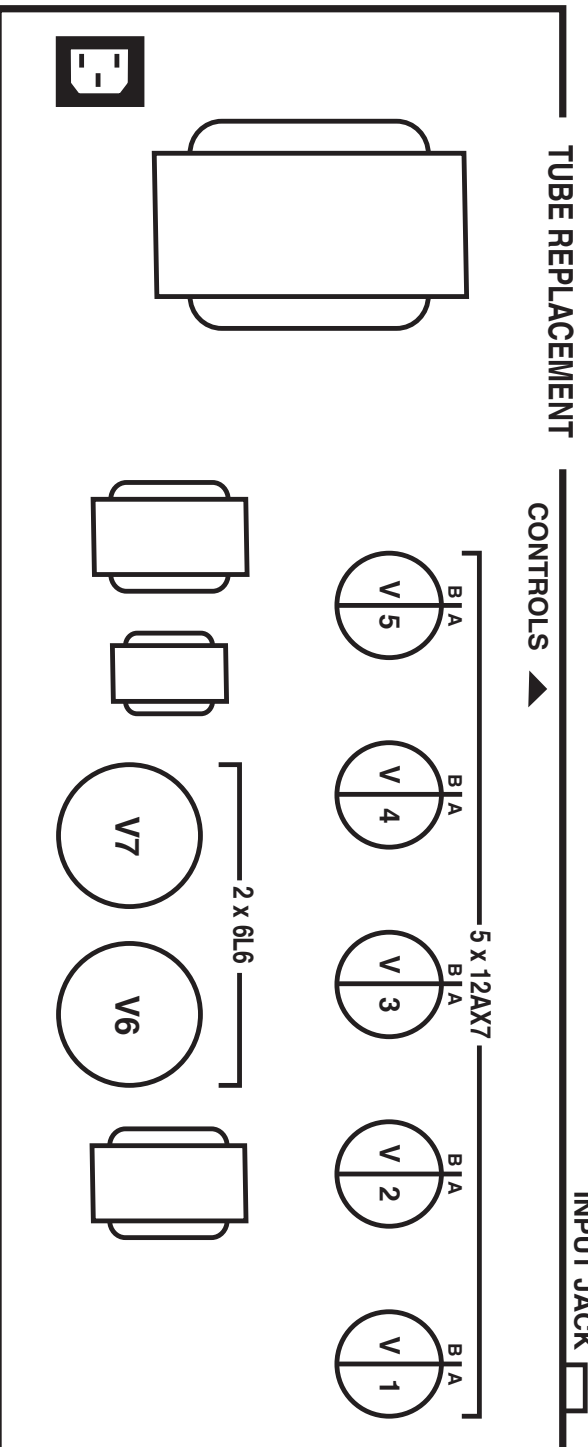

PREAMP TUBES		POWER TUBES	
V1A- 3rd Gain Stage CH 2	V3A- 3rd Stage Clean, 4th Stage Crunch, Blues & Burn	5 Watts = V7	
V1B- 2nd Stage Clean 3rd Stage Crunch	V3B- FX Return Stage	25 Watts = V6, V7	
V2A- Input Stage Crunch, Blues & Burn	V4A&B- Driver	50 Watts = V6, V7	
V2B- 2nd Stage Crunch, Blues & Burn, Input Stage Clean	V5A- Reverb Return V5B- Reverb Send		

TO MAINTAIN WARRANTY, USE MESA/BOOGIE TUBES WHEN REPLACEMENT IS NECESSARY
 FOR CUSTOMER SUPPORT, PLEASE CALL 707-778-6565 MONDAY-THURSDAY 9-5 PST, OR EMAIL US AT INFO@MESABOOGIE.COM

FRONT PANEL: Express 5:25 +

SWITCH
pt# 607231

ALL KNOBS
PT# 408601

2 x SWITCH
pt# 607233

EQ KNOBS - 408550
EQ SLIDER POT - 588536

2 x SWITCH
pt# 607233

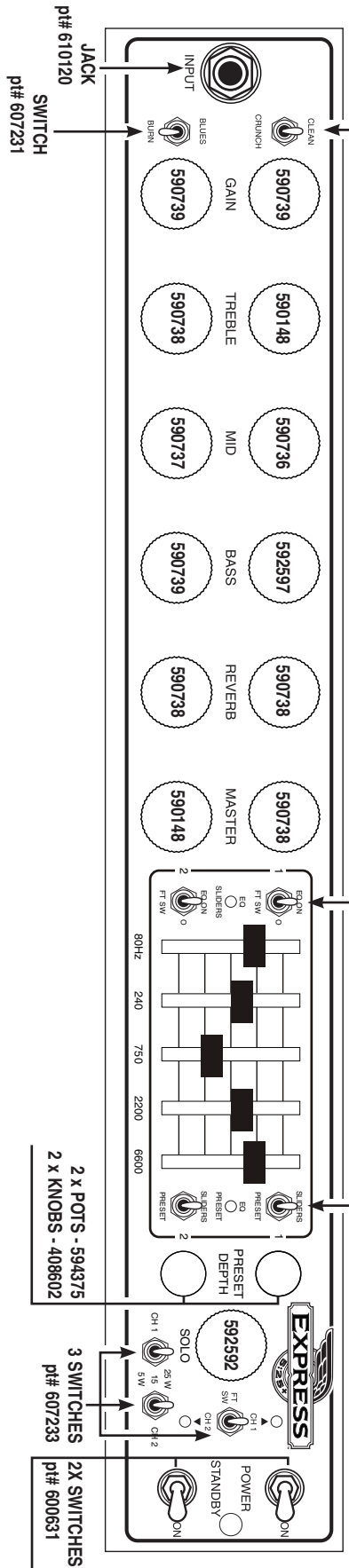

JACK
pt# 610120
SWITCH
pt# 607231

2 x POTS - 594375
2 x KNOBS - 408602

3 SWITCHES
pt# 607233

2X SWITCHES
pt# 600631

REAR PANEL: Express 5:25

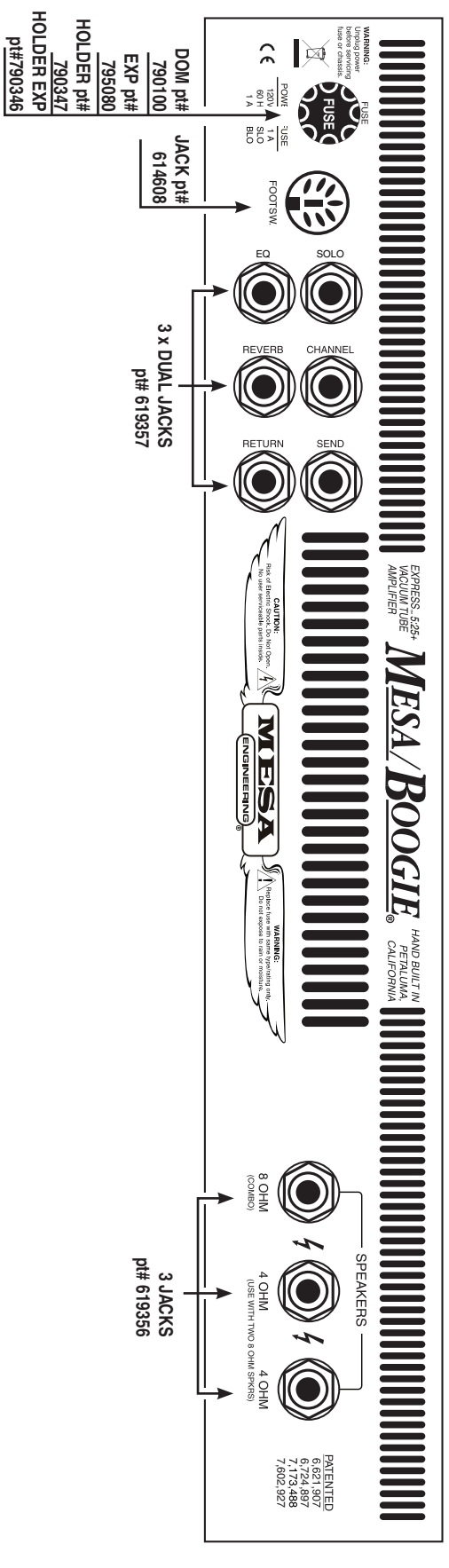

DOM pt#
790100
EXP pt#
795080
HOLDER pt#
790347
HOLDER EXP
pt#790346

JACK pt#
614608

3 x DUAL JACKS
pt# 619357

3 JACKS
pt# 619356

EXPRESS 5:25
AMPLIFIER
MESA/BOOGIE
HAND BUILT IN
PETALUMA
CALIFORNIA



PATENTED
MESA/BOOGIE
6:224.887
7:173.488
7:602.927

FRONT PANEL: Express 5:50+

SWITCH
pt# 607231

ALL KNOBS
PT# 408015

2 x SWITCH
pt# 607233

EQ KNOBS - 408550
EQ SLIDER POT - 588536

2 x SWITCH
pt# 607233

2 x SWITCH
pt# 600631

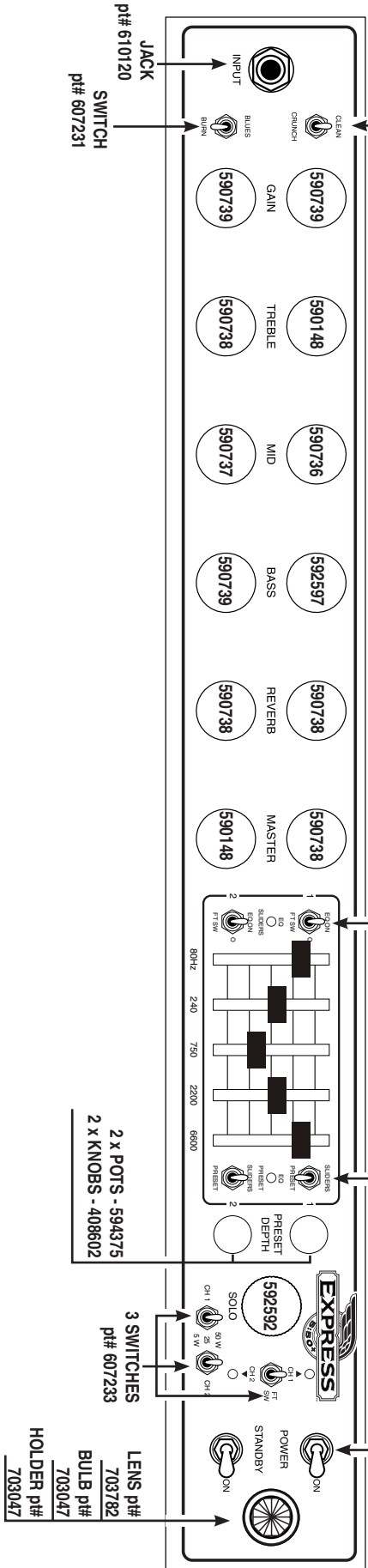

REAR PANEL: Express 5:50+



NOTES

MESA/BOOGIE[®]

The Spirit of Art in Technology

Thank you for trusting MESA/Boogie to be your amplifier company and we wish you many years of toneful enjoyment from this handbuilt all tube instrument.



The Spirit of Art in Technology



(707) 778-6565 FAX NO. (707) 765-1503

1317 Ross Street Petaluma, CA 94954

USA

www.mesaboogie.com

11/13/12