

# *MESA/BOOGIE*



## *Stage II* *Owner's Manual*

## *Hello from the Tone Farm*

*...You, smart player and all around intuitive human, have put your trust in us to be your amplifier company. This is something we do not take lightly. By purchasing and choosing this unit to be a part of your musical voice, you have become part of the Mesa family...WELCOME! Our goal is to never let you down. Your reward is that you are now the owner of a great amp, bred of fine all tube amp heritage...benefiting from the many pioneering and patented Mesa circuits that led to the refinement of your new instrument. Feel confident, as we do, this amp will inspire many hours of musical satisfaction and lasting enjoyment. It was built with you in mind, by players who know the value of a fine musical instrument and the commitment it takes to make great music. The same commitment to quality, value and support we make to you...our new friend.*

## *Table of Contents*

Precautions	1-3
Overview & Instant Gratification _____	1-3
Helpful Hints _____	4

### **FRONT PANEL CONTROLS & SWITCHES:**

#### **THE MODES:**

Channel 1: Fat Clean / Tite Clean / Crunch _____	4-5
Channel 2: Crunch / Tite Clean / Fluid Drive _____	6
Gain, Treble, Mid, Bass _____	7-8
Presence, Master _____	9
Power Select: 100 watt / 50 watt _____	9
Channel Select _____	10
Output Control _____	10
Solo Control _____	10-11
Bold / Spongy _____	11
Standby _____	11
Power _____	11

### **REAR PANEL CONTROLS, SWITCHES & JACKS**

Slave _____	12
Speakers _____	12
Channel & Solo: External Switch Ports _____	13
FX Loop _____	13-14
FX Return As A Power Amp Input _____	14
Rectifier Select: Diodes / Tube Rectifier Tracking _____	14-15
AC Receptacle _____	15
Fuse _____	15
Factory Sample Setting _____	16-17
Personal Settings Page _____	18
Tube Noise & Microphonics _____	19
Diagnosing Power Tube Failure _____	19
Diagnosing Pre Amp Tube Failure _____	20
Bias Adjustment: A feature article by Randall Smith _____	21-23
Speaker Impedance Matching & Hook-up Guide _____	24-29
Triodes, Pentodes & Irishmen: A feature article by Randall Smith _____	30-32
Tube Task Charts _____	33-34
Part Sheet _____	35

# PRECAUTIONS & WARNINGS

*Your MESA/Boogie Amplifier is a professional instrument. Please treat it with respect and operate it properly.*

## USE COMMON SENSE AND ALWAYS OBSERVE THESE PRECAUTIONS:

**WARNING:** EU: permission from the Supply Authority is needed before connection.

**WARNING:** Vacuum tube amplifiers generate heat. To insure proper ventilation always make certain there is at least four inches (100mm) of space behind the rear of the amplifier cabinet. Keep away from curtains or any flammable objects.

**WARNING:** Do not block any ventilation openings on the rear or top of the amplifier. Do not impede ventilation by placing objects on top of the amplifier which extend past the rear edge of its cabinet.

**WARNING:** Do not expose the amplifier to rain, moisture, dripping or splashing water. Do not place objects filled with liquids on or nearby the amplifier.

**WARNING:** Always make certain proper load is connected before operating the amplifier. Failure to do so could pose a shock hazard and may result in damage to the amplifier.

Do not expose amplifier to direct sunlight or extremely high temperatures.

Always insure that amplifier is properly grounded. Always unplug AC power cord before changing fuse or any tubes. When replacing fuse, use only same type and rating.

Avoid direct contact with heated tubes. Keep amplifier away from children.

Be sure to connect to an AC power supply that meets the power supply specifications listed on the rear of the unit. Remove the power plug from the AC mains socket if the unit is to be stored for an extended period of time. If there is any danger of lightning occurring nearby, remove the power plug from the wall socket in advance.

To avoid damaging your speakers and other playback equipment, turn off the power of all related equipment before making the connections.

Do not use excessive force in handling control buttons, switches and controls. Do not use solvents such as benzene or paint thinner to clean the unit. Wipe off the exterior with soft cloth.

**YOUR AMPLIFIER IS LOUD! EXPOSURE TO HIGH SOUND VOLUMES MAY CAUSE PERMANENT HEARING DAMAGE !**

**No user serviceable parts inside. Refer service to qualified personnel. Always unplug AC power before removing chassis.**

**EXPORT MODELS: Always insure that unit is wired for proper voltage. Make certain grounding conforms with local standards.**

**READ AND FOLLOW INSTRUCTIONS OF PROPER USAGE.**



## Instruction Manual

### OVERVIEW:

Congratulations on your choice of the *Stiletto* as your amplifier and welcome to the *MESA/Boogie* Family! This design represents our experience gained over the last several decades hand-building all-tube, high performance amplifiers and showcases ultimate tone and versatility served up with intuitive simplicity.

We wish you many years of inspired enjoyment from your new instrument and feel confident that it will exceed your expectations right away. And as your musical journey unfolds, so will your *Stiletto*, proving its' lasting value as it supports your musical growth for years to come.

While the *Stiletto* is the first amplifier in the *MESA* Family that features exclusively the EL34 type power tube, it is no less endowed with the patented features and refinements than its *MESA* siblings utilizing 6L6 type pentodes for power production. Years of scrutiny and testing of the available '34's was incorporated into the long process of R&D to ensure reliable performance while we were extracting our measure of this revered tubes' golden elixir of harmonic bliss.

The *Stiletto* delivers all the vintage voodoo power-clip characteristics of the best classic British EL34 amps, and yet goes far beyond those gems in terms of gain, expression, nuance and flexibility to put a new standard in place in the realm of EL Based circuits.

We begin with the straightforward 2 Channel platform that presents everything in a one glance, confidence inspiring visual tour of the Front Panel. All the controls you need and nothing more. A closer look reveals two sets of mini toggles adjacent to the input GAIN Control, one 3 position for each Channel, responsible for choosing one of 5 incredible Modes (CRUNCH appears in both channels).

### FRONT PANEL : *Stiletto*

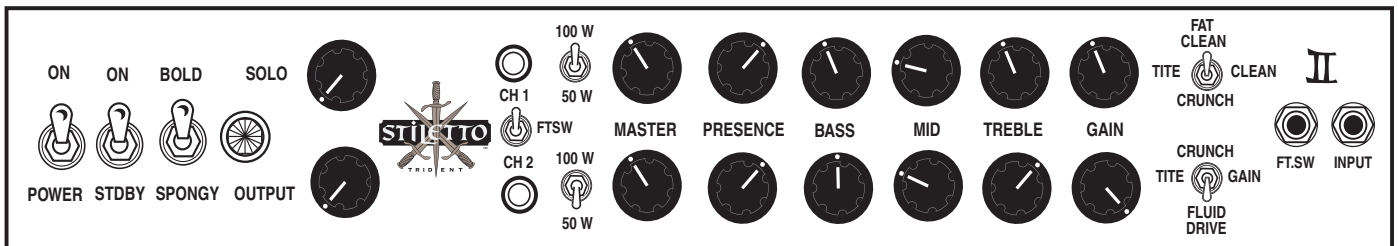

### REAR PANEL : *Stiletto*

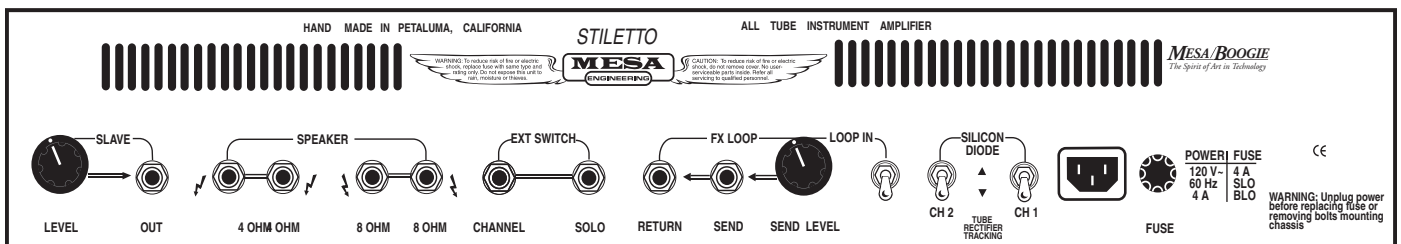

## OVERVIEW: (CONTINUED)

**The Preamp MODES:** In Channel 1 the choices are grouped in reference to gain regions usually associated with Rhythm styles; FAT CLEAN, TITE CLEAN and CRUNCH.

### CHANNEL 1:

The beauty of **FAT CLEAN** re-educates EL aficionados used to living with clean “inputs” that are no more than upstream patch points. Satisfactory, though un-inspiring, we choose to switch in an entire clean-optimized preamp dedicated to sparkling highs, sweet mids and breathing lows. The **FAT CLEAN** mode invites a refreshing, re-defining look at the expectations of clean sounds in this genre of amplifier.

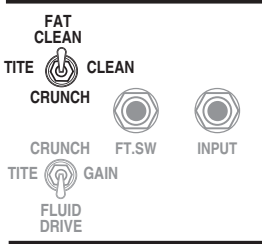

The more stripped **TITE CLEAN** mode trims away some of this low end response and leaves you with an urgent voice where mids and highs dominate and lows support. This difference is perfect when darker mahogany guitars are in use or, in the studio when you need a part to sit in a mix without occupying too much space.

From here gain is increased dramatically to produce **CRUNCH**, an essential, quintessential mode which delivers the spectrum from classic Brit break-up, through tight Southern Crunch and eventually to a smoldering L.A. Grind. This mode is so flexible and its' gain region so inherently right for so many styles, that we repeated it as an option in Channel 2.

### CHANNEL 2:

This channel begins its odyssey into the realm of gain hellacious with an ingenious, yet common sense duplication of the **CRUNCH** mode found in Channel 1. A scheme that proves invaluable, as this versatile mode tops-out at the onset of saturation, offering up a wide and usable range of medium gain. Not just great for rhythm playing, **CRUNCH** reveals a whole world of articulate, earthy solo sounds that leave the vintage or modified circuits seeming a bit inadequate, if not overpriced.

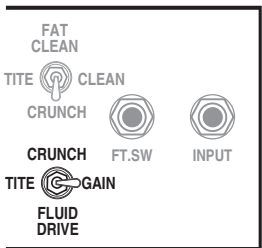

Next, the **TITE GAIN** mode steps into the *MESA* frontier of lead voices with a new and blistering rendition of the classic Brit sound that has been fortified with additional gain and classic *Boogie* focus. This new sound adds a searing harmonic blade to the mid-focused, chest thumping hit so prevalent in the U.K. based circuits and creates an addicting-to-play solo voice that stands proud alongside the likes of our fabled *Recto*, *Mark I* and *Mark IV*.

And finally we come to **FLUID DRIVE**, the highest gain of the 3 modes in Channel 2. This self-descriptive mode adds yet another triode stage to the preamp, unleashing a single note voice of unprecedented liquidity. Notes flow out into in a river of harmonic complexity while retaining authority and depth, spread and focus. Here, the attack of the note is transformed into an instantaneous symphony as it is morphing from an absolute bold event in time - to a spinning wheel of vowel sounds as the envelope changes during decay in response to the rise and fall of input voltage generated by your picking technique.

All this preamp tone and flexibility is only half the story and magic though it is, the power section of the *Stiletto* plays an equal role in making what we call a high performance amplifier. With the *Stiletto* you have options to tune the power to the sound you are searching for, both channel specifically and globally, and these choices point at crucial differences in power response that turn good tone into classic tone.

Each Channel features a 50/100 (50/150 *Stiletto Trident*) POWER SELECT switch that enables you to assign the number of output tubes that will be brought on-line as a Channel is called up. In the *Stiletto Deuce*, 50 watts calls two tubes into service producing a half-power scenario, while the 100 watt setting brings all four ELs to life for big, tight headroom.

The *Stiletto Trident* lets you choose between the clip-able 50 watt two tube scheme, and the crushing might of 150 watts - where all six output tubes unleash a previously unknown frontier of EL aggression.

## OVERVIEW: (CONTINUED)

In addition to the channel specific power option, the *Stiletto* incorporates our patented **TUBE RECTIFIER TRACKING™** feature. This is also a Channel Assignable feature that appears as two toggle switches located on the Rear Panel. These switches allow selection of a Rectifier style - Tubes for a saggy, compressed feel or Silicon Diodes for tight, punchy response. When **RECTIFIER TRACKING** is selected, the proper amount of tube rectification is automatically called up for the high power (1x5U4 in 50w, 2x5U4 in 100w *Deuce* and 3x5U4 in 150w *Trident*) mode. This power-vibe flexibility allows you to zero in on the sound as well as how that sound *feels* to play.

And finally, to further tune the power style, we've included our patented **BOLD/SPONGY™** switch. This useful feature allows you to choose between the full 117 volts of incoming AC LINE voltage in BOLD or, use the SPONGY setting which acts as a built-in variac to knock the incoming line voltage down to a brown-out like condition. This voltage difference also produces a dramatic difference in the way a sound feels to play as well as accentuating different frequencies.

An Effects Loop BYPASS switch allows you to bypass the Loop and all associated circuitry (including the OUTPUT and SOLO Controls which are part of the Loop Return stage) to produce a pure, unaltered signal path for studio work or any time you want the maximum raw urgency of this shining tone blade. When you do choose to switch in the almost transparent Effects Loop, what little difference you might notice is quickly forgotten with the usable power of the OUTPUT and SOLO Controls coming on line. The OUTPUT allows you to adjust the overall level of both Channels with one knob, while the patented SOLO™ feature allows you to preset an additional output level control and switch to it any time for a volume boost during live performances.

A SLAVE OUTPUT with level control is also provided to accommodate using the *Stiletto* as a master head in a large rack system where it can be used to drive processing or additional power for large venues.

Two 4 Ohm and two 8 Ohm SPEAKER OUTPUT jacks enable you to match the impedance of most any cabinet configuration you wish to use.

Now that we have a good idea of the features of your new *Stiletto*, let's plug in and check out a quick demo setting to familiarize you with the basic operation of the modes. You will find an expanded group of possibilities in the rear of this manual under SAMPLE SETTINGS for your enjoyment at a later time.

## INSTANT GRATIFICATION

### INSTANT GRATIFICATION

### Rear Humbucker

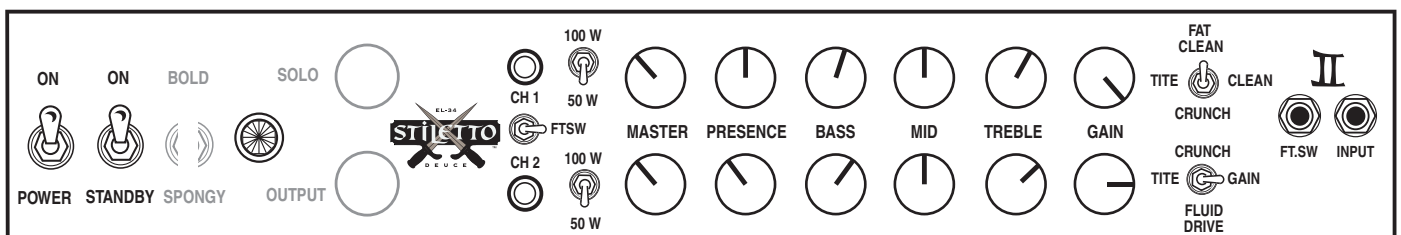

### INSTANT GRATIFICATION

### Ch1 Neck / Ch 2 Rear

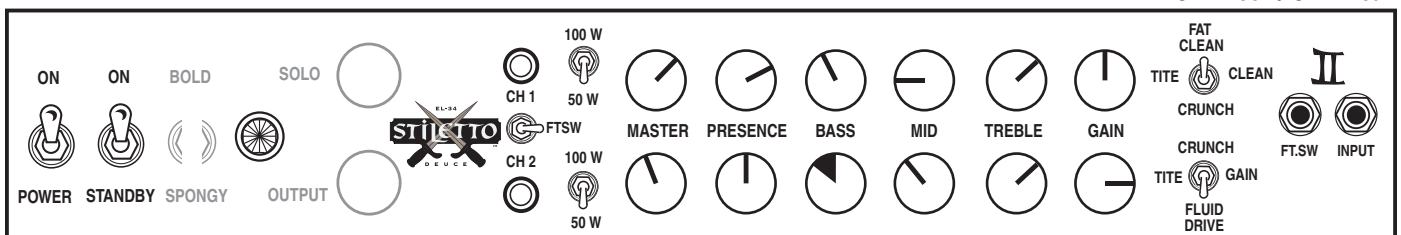

Armed with a new perspective of just how incredible your new *Stiletto* really is, we can now take a closer look at each of the controls and how they interact to produce your signature sound.

## HELPFUL HINTS:

- 1.) The OUTPUT Control works only when the FX LOOP is activated. Switch out of the Loop Bypass position on the Loop Assign switch to activate the FX Loop and bring the OUTPUT Control on line..
- 2.) The SOLO Control is activated when the Footswitch is connected to the FOOTSWITCH jack on the Rear Panel and the FX LOOP is activated. When the footswitch is not connected the SOLO Control will have no effect on the volume level.
- 3.) When the FX LOOP is activated it is normal to hear the volume drop a bit. Use the SEND Level Control on the Rear Panel even if no processor is patched in to bring the volume level back up to approximately unity gain.
- 4.) The SOLO Control can be set for a volume level *above* that of the OUTPUT Control setting. It will **not** allow a setting below that of the OUTPUT.
- 5.) The GAIN and TREBLE are the most powerful controls in both channels. They should be used with taste and you will find that the best sounds are found with these two controls set somewhere in their middle regions. Avoid setting the TREBLE above 2:00 when the GAIN is maxed as the possibilities for noise and squealing from microphonic preamp tubes increases dramatically.
- 6.) Choosing the proper Rectifier mode with the RECTIFIER SELECT switch located on the Rear Panel that best suits the sound style you are trying to dial can greatly enhance the performance. **TUBE RECTIFIER TRACKING produces a more elastic feel and softer clipping** characteristics which is especially great for single note soloing. **SILICON DIODES produce more power and headroom** and can also track better for extreme gain settings while staying tighter in the bottom end.
- 7.) The PRESENCE Control determines a lot about the voicing of gain sounds. Set lower it will fatten and compress single note sounds and lend a liquid feeling to the strings in Channel 2. Above 12:00 it starts adding cut and tightness in both channels.

Hopefully these tips have helped you in getting ready to enjoy a walk on the wild side and by now you should be getting pretty familiar with your new *Stiletto* so lets move on to understanding and reviewing the rest of the features that are instrumental in helping to shape your sound and tone.

## FRONT PANEL: CONTROLS & FEATURES

### The MODES: Channel 1

As mentioned in the Overview, each of the *Stiletto's* two channels contain three modes of operation. These are laid out, in terms of their gain structure, such that as the mini toggle is switched down, the gain increases. The one exception is in Channel 1, when in TITE CLEAN (middle position) gain in the bottom end is reduced.

Channel 1 is dedicated to a range of gain more suited to Rhythm playing with two modes that are lower gain - aimed at clean chording, and one medium gain mode aimed at crunch rhythm styles.



**FAT CLEAN** (toggle up) walks the line between many of our previous clean circuits to produce a mode that can be as versatile as it is vintage. It traces its' lineage back to the best of the Black Face era and pays tribute to the bloom and lushness of those American classics - while at the same time retaining the boldness, shimmer and punch of the early *Mark I Boogies*.

These qualities, when combined with the classic EL34 top-end sting and mid attack found in some of the best Brit circuits, unveil a clean mode that resonates with players of both camps and brings a new and exciting personality to the world of rhythm sounds. This mode works extremely well for clean soloing with an emphasis on rich bass frequencies that fill-in and round-out notes in the higher registers, giving even the B and E strings body and depth high up on the neck.



## FRONT PANEL: CONTROLS & FEATURES *(Continued)*

### The MODES: Channel 1 *(Continued)*

Because the voicing of this mode is heavy in these rich lows, it will be necessary at times to reduce the setting of the BASS Control, especially when higher settings of the GAIN Control are to be used. Some amazing clipped or pushed sounds are possible with the **FAT CLEAN** mode by cranking the GAIN and setting the BASS at 0 (7:00/off). Here, an addicting smoothness is always present because the sub-low frequencies are allowed to pass freely and the entire spectrum warms up and exudes soulfulness. Even when the BASS Control is used to trim away some of these lows, a fat smooth voice remains that you will find useful for many applications.

**TITE CLEAN** (toggle in middle position) is the opposite in every sense. This mode is stripped of sub-lows and lower mids creating a focused, immediate attack characteristic that can be described as unabashed forwardness. **TITE CLEAN** works great for chording and parts played here will sit proudly and uniquely in a mix...even a complex one, because they require little space to tell the story loud and clear.



When clipped, this mode behaves in a brash, urgent manner and with more bass frequencies trimmed early on in the preamp, the BASS Control may be used to dial in tighter lows that compliment the top-end perfectly. In fact, for clipped sounds in the Rhythm Channel, **TITE CLEAN** would almost always be the preferred choice. The balance in all frequencies will result in the most cohesive distortion character, where the added gain stays more glued to the notes. Be sure to check out using **TITE CLEAN** in combination with the 50 Watt power selection, the BOLD/SPONGY switch set to SPONGY and the TUBE RECTIFIER TRACKING selected on the Rear Panel for some truly amazing power clip sounds.

**CRUNCH** (toggle down) is the ultimate in tight, urgent grind. The added gain in this mode, combined with immediate attack and a brash attitude, makes this mode the old school Rock 'N Roll dictionary of Brit inspired guitar sounds. This range of "medium gain" is so versatile that you could use this mode alone for years, finding both great rhythm and solo sounds that are accurate, articulate and expressive.



Because the **CRUNCH** mode is not as saturated, even at a maximum setting, as the two high gain modes in Channel 2, it responds very well to adding additional gain by utilizing the switchable power features. This mode spreads the perfect glazing of gain to give the right amount of attitude without covering up the natural character of your guitar.

The inherent chirping harmonics are further enhanced by switching down to SPONGY which emphasizes top end shimmer while scooping out a nice narrow slice of midrange. Choosing the TUBE RECTIFIER TRACKING sags the power down even further and adds a creamy, legato feel - making single note playing effortless, while removing any hint of harshness and elevates this mode to an incredible solo voice.

The incredible expression and versatility of the **CRUNCH** mode prompted us to provide a duplicate of this sound among the choices in Channel 2. After becoming familiar with the many uses for **CRUNCH**, you will quickly discover the value of being able to use it for one of two scenarios; either two slight variations of this mode set for similar gain ranges (using the two individual MASTER Controls for levels) or, vary the gain range and use one for rhythm and one for soloing.

However you wish to dedicate your Channels, you will likely find **CRUNCH** to be one of the most important and essential modes in your *Stiletto*.

Now that we have reviewed the modes in Channel 1 and understand the voicings, let's move down to Channel 2 and get to know the modes in your *Stiletto* dedicated to higher gain soloing.

## FRONT PANEL: CONTROLS & FEATURES *(Continued)*

**The MODES: Channel 2 CRUNCH:** See the description of this mode under Channel 1 as it is duplicated here in Channel 2. Don't underestimate this mode for its' soloing potential. Despite the lower gain range, it has virtues for lead work the other higher gain modes are missing due to their more saturated character.



Though the **CRUNCH** modes are basically duplicated in the two channels, there is a difference in how you must set them in relation to the PRESENCE Control.

**NOTE:** The PRESENCE Control in Channel 2 uses a different (slower) taper pot so that the two higher gain modes will work properly and allow you a better range of Presence settings. The PRESENCE Control in the **CRUNCH** mode in Channel 2 will need to be set higher to achieve the same sound as the **CRUNCH** mode in Channel 1 set with all the other controls the same.

**TITE GAIN** (toggle in middle position) takes the classic EQ curve of CRUNCH with its' bold, forward mid attack and chirping, articulate top and kicks the gain up several notches to create the ultimate high gain lead sound with an unmistakable Brit character. Adding compression and sustain to an already classic sound, the extra gain allows **TITE GAIN** to sing with conviction and authority and yet it still retains all the articulation and accuracy of its lower gain cousin CRUNCH. For those who have grown up on classic British circuits or rely on them for a large part of their style, **TITE GAIN** is a single note tone fantasy that will elevate your soloing to new heights. The less resistant feel on the strings will have you burning...smashing your previous metronome boundaries with an effortless flow and sense of confidence you have likely never experienced.



For de-tuned moshing there may be no equal to **TITE GAIN** (except of course for our *Dual* and *Triple Rectifier Solo Heads*). **TITE GAIN** is tailor made to keep the low frequencies in line and tracking tight. The obvious mid range focus and lack of sub-lows here ensures that your de-tuned grooves will cut with a ferocious intensity and stop on a dime when you cut off the notes. Tight, searing, and honed to a glistening stainless polish, the *Stiletto's* **TITE GAIN** is the ultimate blade in the world of modern hyper-gain rock.

**FLUID-DRIVE™** oozes with smoldering, layered harmonics and represents the highest gain mode in your new *Stiletto*. Its namesake pays tribute to the type of playing that it shines for, and like TITE GAIN, it will have you breaking all tempo barriers in no time with its consistent string resistance and easy-to-play-feel across the entire range of the instrument.



Compressed and fat, smooth and vocal, **FLUID-DRIVE** is the ultimate voice for memorable melody lines or liquid lead lines that drip with soul. This is often the perfect compliment to other guitarists in the band or for when you need your lines to have added girth. No British circuit has ever come close to delivering a solo sound with this depth, breadth or intensity through a power section driving the EL34, and this catapults the genre into a new realm of single note solo mastery.

For high gain chording or rhythm work, **FLUID-DRIVE** can produce a wall of layered harmonics that can grind with the best of the *Stiletto's* vintage sounds and is definitely worth auditioning for thicker rhythm parts. You will want to dial these two regions more carefully and possibly lean a little harder on the TREBLE and MID to achieve the best balance and retain the tightest attack.

Hopefully the descriptions of the Modes and their possible applications have given you some insight as to how to configure your Channels to give you the greatest flexibility. Now let's move to the rest of the Front Panel and check out the controls and switches.

## FRONT PANEL: CONTROLS & FEATURES *(Continued)*

While you have most likely taken your new *Stiletto* for an inspiring spin around the world of high performance EL34 tone, we encourage you to read through the Control section to learn how these interactive controls can shape your dream tone. Many hours were spent making sure they are powerful, musical and that they will deliver all the shaping power you'll ever need to craft a signature sound all your own.

**GAIN:** This control adjusts the predominant gain stage in each channels' circuit with the function and taper being optimized for each individual channel. Remember that your *Stiletto* is really two separate multi-mode amplifiers built onto one chassis, so though each channel looks identical, the **GAIN** Control for each channel comes in a different place and adjusts a different point in that channels circuit.

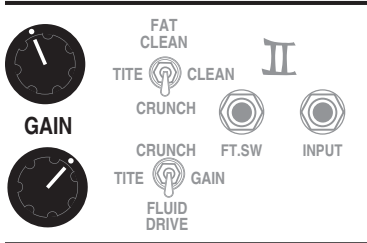

In most guitar amplifiers, and especially in all-tube circuits, the **GAIN** Control is the most powerful control in the preamp. It shapes the overall style and character of the sound and is responsible for whether the sound is clean, overdriven or anywhere in between.

In your *Stiletto*, the **GAIN** Control is even more powerful. It not only determines the amount of drive, but also acts as an integral part of the tone control string as well.

### 1) The **GAIN** Control has basically three tonal regions -

**Low (7:00 - 11:00)** provides the cleanest, least saturated sounds and in this region the sound will be brighter and contain more upper harmonics lending a three dimensional character to the sound.

**Middle (11:15 - 2:00)** enhances the saturation and replaces some of the upper harmonics with a richer, warmer quality and a fuller bottom end response. Not yet fully saturated, this region is the easiest place to get a great sound in both channels. This region contains many of the *Stiletto*'s best sounds...especially for soloing due to the crucial blend of an expressive attack combined with ample sustain.

**High (2:15 - 5:00)** saturates the signal and enhances low and low mid frequencies. While this region provides the maximum saturation and therefor sustain, it also compresses and softens the attack characteristics.

**NOTE:** Due to the *Stiletto*'s extreme gain potential, the highest regions of the **GAIN** Control may possibly push the pre-amp tubes past what they can handle, producing microphonic squealing. While we screen and test the tubes your amplifier was shipped with and the tubes in your amp passed our rigorous test, we can't predict how the tubes will respond over time exposed to extreme gain settings. Your tubes are warranted for a period of 6 months under normal use, but you can save yourself the present and future inconvenience of having to deal with annoying microphonic tube problems by simply using **a little common sense...Don't turn the Gain all the way up with the Tone Controls at their maximum settings!**

If you must for a specific part or at very low volumes, back down the **TREBLE** and **PRESENCE** Controls. Your *Stiletto* was designed to provide amazing gain and tone at less than extreme settings removing the need for you to crank everything all the way up. If you are not able to achieve the sound you want at sensible settings on any or all of the controls, your problem may lie elsewhere in the signal chain, i.e. pick-ups, cabinetry, processing etc. Keep in mind you can always call on one of our product specialist Monday through Thursday and seek some advice should you find yourself struggling to get the sound you want.

**2.) GAIN - In conjunction with the Tone Controls** - Basically, a simple rule applies...as the Gain is increased the Tone control string has less and less effect on the signal until at 5:00 the signal is so saturated that you are *getting mostly Gain and very little Tone*. Again, this is the reason we suggest using the **GAIN** Control in its middle region. Here the Tone control string is very active and provides maximum shaping power - allowing you to dial virtually any sound you desire.

## FRONT PANEL: CONTROLS & FEATURES (Continued)

**TREBLE:** As in most tube guitar amplifiers, the **TREBLE** Control (in both channels of your *Stiletto*) is the most powerful of the rotary controls and is next in line only to the **GAIN** Control as a shaping tool. Because it is first in the signal path of the tone controls - and from here the Middle and Bass receive their signal - it is by far the dominant tone control. For this reason the setting of the **TREBLE** Control is very important for equal representation of the three frequency regions to appear at their respective controls. Like most of the controls on your *Stiletto*, there is an optimum region of the **TREBLE** Control where ample top end is mixed in and yet enough signal is still passed on to the **MIDDLE** and **BASS** Controls.

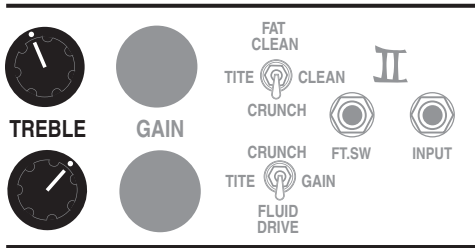

As you might surmise, here is the *sweet spot*. There are definitely great sounds above and below this middle region (11:00 - 1:30), but the balance between the **TREBLE** Control and the other two tone controls is compromised.

The one place you may want to throw caution to the wind and set the **TREBLE** Control above this median zone presents itself in Channel 1. In **CRUNCH**, the **TREBLE** Control can be used to dump extra gain into the mix. This is especially effective for crunch sounds. When doing so, use the **PRESENCE** Control to roll off some of the more than ample top end for a more compressed feel and fatter voice. As you might surmise, the **BASS** Controls' effectiveness will be reduced, so you may have to run a much higher setting than you are used to seeing to achieve a balance. This said, keep in mind that the **TREBLE** Control in Channel 1 **CRUNCH** should not be set much above 2:30 to avoid unwanted microphonic tube problems.

**MID:** The **MID** Control is responsible for the blend of midrange frequencies in the mix and though its effect is not as dramatic as that of the **TREBLE** Control, it plays an integral part in achieving any sound in your *Stiletto*. It is capable of changing the feel dramatically as it blends in a group of frequencies that tend to soften or stiffen the way a sound feels to play.

Many players tend to lean in the direction of lower **MIDDLE** Control settings (7:00 - 11:00) where a scoop in this region produces *girth* (by letting the Bass become a little more dominant) and a lack of punch lends a more compressed, *even* feel to the strings and therefore less apparent resistance to the pick. As the **MIDDLE** Control is increased, (11:30 - 1:30) the sound is rounded-out and filled-in with a focused mid attack appearing rather quickly. As you would guess, the feel starts to change - becoming more resistant. Above this region the **MIDDLE** Control could be used to compensate for either weaker pick-ups or for times when a specific deficiency is produced by either an extremely high setting of other tone controls, or a physical anomaly in the room. While these **MIDDLE** Control settings (2:00 - 5:00) can introduce added gain and create enhanced focus, the trade-off will be a stiffer, more forward, less compressed feel.

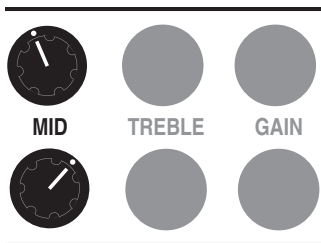

**BASS:** Last, but not least in the string of tone controls we come to the **BASS**. This control works similarly in both channels in that it determines the amount of low frequencies present in a sound. However, the actual frequencies and *style of lows* it mixes in changes from channel to channel and within the different modes. Like the **MIDDLE** Control, it falls in line signal-wise *after* the **TREBLE** Control and the same scheme applies. When the **TREBLE** Control is set high, the effectiveness of the **BASS** and **MIDDLE** Controls is reduced. If the **TREBLE** Control is set low these two controls become dominant.

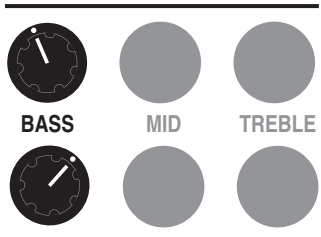

For the most balanced sound and a balance of power between the three rotary tone controls, try to use the **TREBLE** Control in its middle ranges. This scenario produces nearly equal representation of all the frequencies on the tone controls and provides a great neutral starting point for further tweaking.

## FRONT PANEL: CONTROLS & FEATURES *(Continued)*

**PRESENCE:** The **PRESENCE** Control is a high frequency attenuator that is placed at the end of each channels pre-amp stage and affects frequencies higher than those of the TREBLE Control. It acts independently of the other rotary tone controls and is crucial in voicing the channel. It is a powerful global tone control. Lower **PRESENCE** Control settings darken and, in fact compress the signal which works well to fatten single note solo sounds, giving them girth and focus. Some of the best lead sounds in your *Stiletto* will find the **PRESENCE** Control in its lower regions, where a balanced, vocal response is achieved.

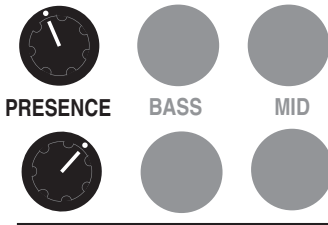

Higher settings unleash the mighty roar of your *Stiletto* and this can be great for sparkling clean sounds in Channel 1 and more aggressive crunch rhythm sounds in the high gain modes. Be sure to taunt the beast that lurks in Channel 1 and 2's CRUNCH mode as the **PRESENCE** is truly amazing in this most agro mode.

**MASTER:** This control is the master feed from the end of the pre-amp to the driver stage and the Effects Loop. As you can see each Channel is fitted with its own **MASTER** Control, enabling the channels relative volumes to be matched regardless of their extremely different sound styles and gain signatures. The **MASTER** Control makes possible a wide range of sounds through its ability to use very low **Gain** sounds at high volumes and conversely, high **Gain** sounds at low volumes and everywhere between.

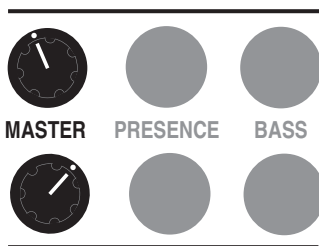

Again, we suggest using the **MASTER** Control in its *sensible* ranges (9:00 - 2:00). Here, the channels will be easier to match with each other and the Effects Loop will see more reasonable signal levels.

**NOTE:** Because the **MASTER** Control creates the send to the Effects Loop, extreme settings will cause a large signal to be sent to the Loop for that Channel. Not only may this cause possible overloading of the processors Input stage, but will make balancing the two channels' Effect Send level difficult.

**100 W / 50 W: Channel Power Select:** These mini toggles determine the power section mode for each channel and can be switched at any time during performance, or when the amplifier is in STANDBY. The choices are 100 watt (150 watt - *Trident*) or 50 watt (*Trident* and *Deuce*). In the 100 watt setting all four (all six, 150 watt - *Trident*) power tubes are on line and delivering the maximum power and headroom. (Assuming all other power switching features are set for max power.) In the 50 watt setting, only two of the four (or six) power tubes are operational and the rest are in a standby mode.

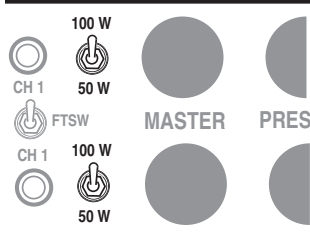

This power programmability is a powerful feature that allows you to tune the power rating to the style of preamp performance you have set up and create a sound that is both stylistically accurate and inspiring to play. Combining the power selections with the other switchable power features takes this concept even further to create the ultimate EL34 tone weapon.

**NOTE:** When using the **POWER SELECT** switch in the 50 watt mode, try experimenting with the 4 Ohm SPEAKER OUTPUT. This selection creates a "more proper" impedance match and imparts a slightly brighter, snappier voice. This is not critical to performance as the *Stiletto* is not overly sensitive to impedance, but you may prefer this EQ characteristic.

If you prefer the 8 Ohm speaker tap for its bolder, rounder tone, by all means continue to use it, either way is fine and you need not consider which one you use as far as reliability goes. We just wanted to give you this little tip and we always encourage experimentation on the path to finding your ultimate tone.

## FRONT PANEL: CONTROLS & FEATURES *(Continued)*

**CHANNEL SELECT:** This 3 position switch - located in the center line of the chassis between the two channels - is responsible for selecting the desired channel when the *Stiletto* Footswitch is not being used. This comes in handy in the studio where you may wish to use the head in the control room with the cabinet isolated and select the channels for overdub parts, or any time the footswitch is not needed for performance.

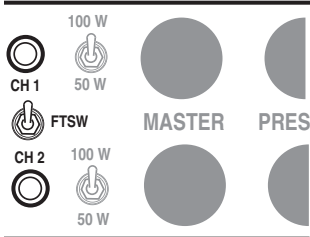

To use the Footswitch, set the mini toggle in the center position - labeled **FTSW** - and connect the standard stereo cable to the FOOTSWITCH jack on the far right of the Front Panel. Selecting one of the Channels with the Channel Select toggle when the Footswitch is connected will override the Footswitch.

**OUTPUT:** This control determines the overall output volume level of the amplifier. After the GAIN Controls have been set for the desired sound style and the two channels levels have been balanced with the channel MASTER Controls, the **OUTPUT** Control allows you to change the playing level by adjusting a single control. The **OUTPUT** Control is also wired as the Effects Loop Return Level

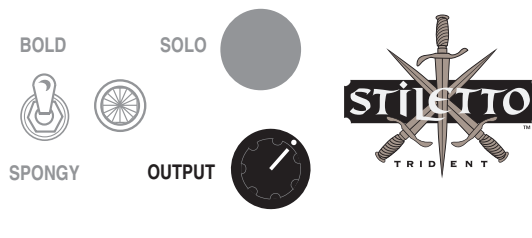

Control. Should you ever use your *Stiletto* amplifier as a power amp alone by inserting a signal into the RETURN jack, the **OUTPUT** Control will serve as the master level control.

**NOTE:** When using the EFFECTS RETURN as an input - to use the *Stiletto* amplifier as a power amp - the SOLO Control can be used to attain a footswitchable boost if the Footswitch is connected. It is wired in parallel to the **OUTPUT** Control and therefore controls the volume of the power section as well.

**NOTE:** The Effects Loop RETURN jack can serve as a power amp input so that you may use the *Stiletto* amplifier as a power amp for either stereo reproduction or to incorporate additional pre-amps. Here are a few things to remember that will help you when interfacing to the *Stiletto* for use as a power amp only;

- 1.) The OUTPUT Level will be the only active control on the Front Panel (the PRESENCE Control of Channel 1 will be active only when that channel is engaged).
- 2.) The SOLO Control may be used to footswitch to a pre-determined amount of boost when the footswitch is connected.

**SOLO:** This control can only be activated if the correct Footswitch is connected to the Footswitch jack. **SOLO** is an additional final output level control wired in parallel with the OUTPUT Control. It is capable of a setting above that of the OUTPUT Control and can not be set below. The amount of apparent boost also depends on that of the OUTPUT Control - in that if the amplifier is at either the extreme low or extreme high levels of the OUTPUT, its effectiveness is minimized. It has been optimized for live performance volume levels.

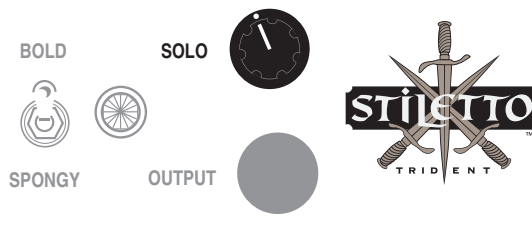

## FRONT PANEL: CONTROLS & FEATURES *(Continued)*

**SOLO:** *(Continued)* If the power section is either not a part of the sound (super quiet), or producing all its rated wattage (super loud), there is very little signal for the **SOLO** Control to work with. By using the Footswitch and selecting **SOLO**, a pre-settable boost in overall level is possible on the fly...giving you some control over your level when it's time to step out. Engineers may give you a bit of a frown the first time you use it...but isn't it time you heard yourself. It might even prevent them from punishing you with the dreaded monitor or sidefill version of your tone.

**BOLD / SPONGY:** There are two A.C. power selections available in your *Stiletto* head and each is equally important when looking for a particular sound. "**SPONGY**" works like a built in Variac, reducing all the internal voltages for a true vintage feeling and that extraordinary "brown sound." Power is reduced somewhat too, making it easier to achieve an overdriven power sound, especially when the RECTIFIER SELECT switch is set to the TUBE RECTIFIER TRACKING position.

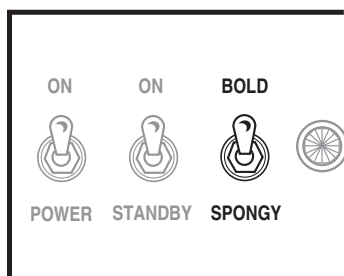

Using either *Stiletto* Head in the **SPONGY** power setting will also extend tube life and overall reliability, while still producing enough power to work many of your gigs...and all of your recording needs!

With the *Stiletto* POWER SELECT switch in the **BOLD** position, maximum power, clean headroom and volume are obtained.

**STANDBY:** Perfect for set breaks... this toggle switch also serves an even more important purpose. In the Standby position the tubes are at idle so that during power up they may warm up before being put to use. Before Power is switched on make sure the **STANDBY** switch is in the Standby position.

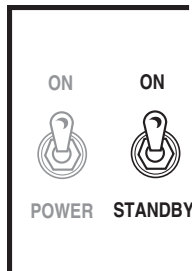

Wait at least 30 seconds and then flip the **STANDBY** switch to the ON position. This prevents tube problems and increases their toneful life substantially.

**POWER:** This switch delivers the A.C. power to the *Stiletto*. Make sure the unit is grounded (all three terminals of the A.C. power cord must be connected whenever possible to avoid injury to the user as well as to the unit) and that the proper voltage is present. Follow the cold start procedure described in the ON/ STANDBY section above when powering up your new *Stiletto*.

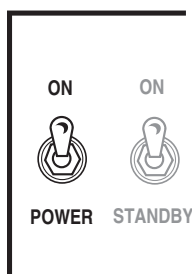

Now that we've covered the Front Panel Controls & Features, let's spin around to the back side and go through the features that call the Rear Panel home as there is more valuable and intuitive shaping power available there.

# REAR PANEL: CONTROLS & FEATURES

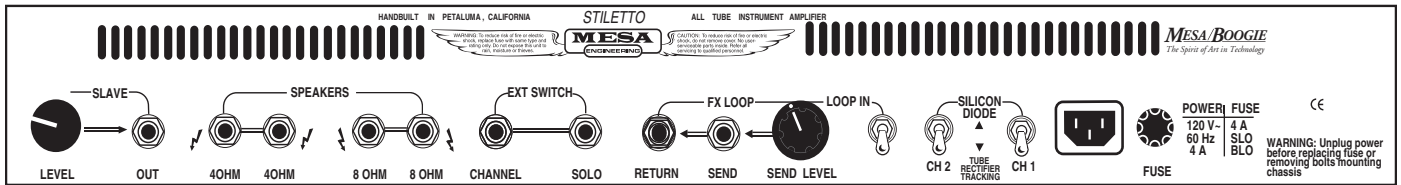

**SLAVE:** This 1/4" jack and its' associated LEVEL Control capture the entire sound of the amplifier, both preamp and power section, and give you an adjustable signal you can use for feeding outboard processing and/or additional power amplifiers. This signal is derived from the speaker output and is then padded down to provide a usable range that will be appropriate for either the input stage of a processor or the input of an external power amp.

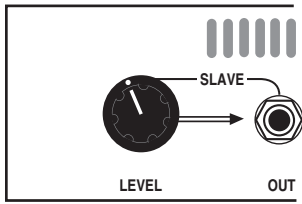

The **SLAVE** output is not like the effects loop - in that once a signal has been taken from the **SLAVE**, it can not be returned to the *Stiletto* RETURN jack or Input. Doing so will result in a feedback loop which will produce a high pitch squeal much like a microphone held to a monitor.

Because the *Stiletto* is a high performance concert-ready head, this output is provided as a one-way-send, intended for feeding large outboard rack systems which in turn feed additional tube power amplifiers. In this scenario, the *Stiletto* would be a "dry" master head (tone generator) and this sound would then be fed via the **SLAVE** output - to a rack of processing, then that signal would likely be split into stereo and fed to one or more stereo amplifiers for amplification of the separate "wet" sound. This scheme, while cumbersome and expensive, ensures the best big venue tone, as it preserves the original master heads' sound and gives you separate control over the wet sound in a parallel world. This separate treatment of the processed sound mimics having separate channels of processing on playback in a recording console and is the ultimate way to make sure there are no compromises in your live tone.

**NOTE:** While you can use almost anything as additional slave amplifiers, may we humbly suggest that using another *Stiletto* for mono enhancement or, one of our dedicated rack mount all-tube stereo power amplifiers for stereo rigs - will preserve and in fact enhance the original *Stiletto* dry signal. (Call us and ask to speak with a Product Specialist who can advise you as to which stereo model would best suit your needs). We have designed these stand alone power amplifiers to deliver ultimate Tone, might and portability and when combined with your *Stiletto*, they will create a dream rig of mind-bending performance.

**SPEAKERS:** These are the Speaker Outputs for connecting your cabinet(s) of choice. Your *Stiletto* is not very sensitive to impedance mismatching and therefore we encourage experimentation with regards to speaker loads. You may feel free to try an 8 Ohm load on the 4 Ohm jack or a 16 Ohm load on the 8 Ohm jack as you may discover a characteristic that the mismatched load imparts on the sound that is desirable.

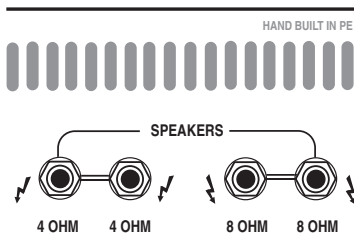

*MESA* 4x12 cabinets are wired in Series/Parallel and are rated at 8 Ohms and these should normally be connected to the 8 Ohm jack. When using two *MESA* 8 Ohm 4x12 cabinets, connect them each to a 4 Ohm jack as doubling the load on each jack produces a total load of 8 Ohms and is a proper impedance match.

Feel free to use speaker cabinets built by other manufacturers (at least until such time you can check out a *MESA* cabinet) and these are often wired to produce a 16 Ohm load which you would want to connect to the 8 Ohm jack. Two 16 Ohm cabinets would be connected each to an 8 Ohm jack. Overall your *Stiletto* is very impedance friendly and most speaker loads will work great with the exception of slightly shorter power tube life occurring when a mismatch in the low direction (two 4 Ohm cabs - each in a 4 Ohm jack to produce a total load of 2 Ohms) is used for long periods of time.



## REAR PANEL: CONTROLS & FEATURES *(Continued)*

### CHANNEL & SOLO: External Switch Ports:

These jacks provide an external trigger port for the Channel Select and SOLO functions. They may be connected to an external master controller (usually MIDI programmable) so that one command can control all footswitchable functions on your *Stiletto*, along with any midi program change commands sent to your outboard processors. This is a great feature that will allow you to avoid the dreaded pedal board dance.

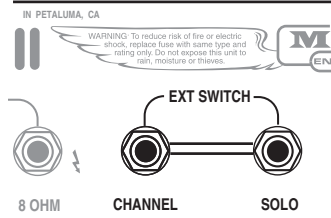

The **EXTERNAL SWITCH** jacks respond to latching type logic where the “tip” is shorted to the “ring” or ground. This is also referred to as tip-to-ground logic and is the most common type of switching logic used in tube musical instrument amplifiers. Simply connect a standard unshielded 1/4” cable to the *Stiletto* **EXTERNAL SWITCH** jacks and connect these to a latching tip-to-ground port on the master switching device. Refer to the master switcher’s manual as to how to control and store the function jacks under a program.

### FX LOOP:

Your *Stiletto* is fitted with a Series Effects Loop for interfacing outboard processing. The Loop is placed at the junction between the preamp and the power amp and is optimized for levels that will match up with most good quality processing devices. A SEND LEVEL Control is provided to fine tune the signal strength coming from the preamp and allows for some compensation for extreme Channel MASTER settings. As mentioned earlier, the Front Panel OUTPUT (and SOLO) Control is part of the Effects Loop Return stage and therefore these are not active when the Loop is switched out of the circuit.

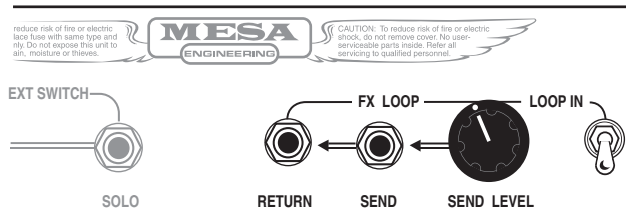

As you have probably noticed, the Loop may be switched out of the signal path completely using the LOOP IN/HARD BYPASS switch located adjacent to the loop. This switch engages the Loop SEND and RETURN jacks, SEND LEVEL Control, OUTPUT and SOLO Control and all associated circuitry. When LOOP BYPASS is selected (switch

down) the entire Loop is removed from the signal path and the individual Channel MASTER Controls become your final output level controls. This HARD BYPASS feature allows you to use your *Stiletto* in all its’ raw glory in the studio where processing will be added later on a separate channel and you need every ounce of pure, unfiltered, Tone for a magical performance.

To use the **FX LOOP**, start by using premium quality shielded cables of the shortest possible length (preferably no more than 3 feet).

- 1) Connect the SEND to your processors INPUT.
- 2) Connect the RETURN to your processors OUTPUT.
- 3) Set the two Channels to your dedicated sounds and levels using the Channel MASTER Controls.
- 4) Select LOOP IN on the LOOP Select switch.
- 5) Set your processors’ INPUT Level control for unity gain.
- 6) After playing in the two channels, Adjust the Rear Panel SEND LEVEL to achieve a good unity gain peak level (remember that clean sounds will peak a bit higher because of their more dynamic, less compressed nature).
- 7) Adjust the Front Panel OUTPUT Control to the desired playing volume.
- 8) Connect the Footswitch (to the Front Panel FOOTSWITCH jack, select SOLO and adjust the SOLO Control for the desired amount of volume boost.

## REAR PANEL: CONTROLS & FEATURES *(Continued)*

### FX LOOP: *(Continued)*

You will find the **FX LOOP** a welcome feature for all rack type processing and when good quality cables are used and kept to a length of 3 feet or less, you will notice very little if any degradation in the sound of your *Stiletto*.

**NOTE:** Because the **FX LOOP** is wired in series with the main signal, it is very important that you choose processing devices that are of professional grade quality from reputable manufacturers. In a series configuration, your amplifiers sound will depend on the integrity of the processors' input and output stages, because you have inserted something into the heart of the most sensitive place in your amplifier.

### USING THE FX RETURN AS A POWER AMP INPUT:

You may, at times, wish to use the *Stiletto* as a stand alone power amp for amplification of processing or as half of a larger stereo rig. Because of the channel and mode specific changes that take place internally you will want to follow the suggestions below for the best results.

- 1) The FX LOOP SELECT switch must be set to LOOP IN (Loop engaged).
- 2) The FX LOOP RETURN jack is the INPUT to the power section. This jack bypasses the entire preamp including the GAIN and all the Tone Controls.
- 3) The OUTPUT is your level control.
- 4) You may use the SOLO Control for a footswitchable volume boost (Footswitch must be connected).
- 5) You may use the Front Panel POWER SELECT switches to select a power rating that is appropriate for the venue or application.
- 6) The choice of rectifiers is still available when using the *Stiletto* FX RETURN as a power input. Remember that this choice is channel specific. The SILICON DIODE selection is more in line with what you would find in most all other stand alone power amplifiers, but for guitar applications it is nice to have the choice of the saggy response of tube rectification.

### RECTIFIER SELECT: Diodes / Tube Rectifier Tracking

These channel specific switches determine the type of rectification the power section of your *Stiletto* will operate on. The choices are the solid state **SILICON DIODES** which convert the A.C. to D.C. with

a constant stiffer, tighter character or, **TUBE RECTIFIER TRACKING** which monitors the Front Panel POWER SELECT and auto-selects the proper number of 5U4 rectifier tubes for a saggy, compressed power feel. This patented switchable choice of rectification is at the heart of being able to nail the sounds we all hear as classics and imparts a feel on the strings like no other element in a guitar amplifier. Tube rectification is especially important when trying to dial-in vintage type sounds where - in the era before *MESA* introduced the

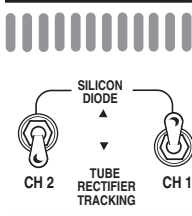

# REAR PANEL: CONTROLS & FEATURES (Continued)

## RECTIFIER SELECT: Diodes / Tube Rectifier Tracking (Continued)

world to the high gain preamp, power clip characteristics were the only way to get a heavier sound. As the power section tries to draw more current at higher volumes, the tube rectifiers begin to sag and compress the sound while scooping the harder midrange frequencies, creating an ultra expressive power signature. Solid state rectifiers do the opposite and deliver a steady, stiff supply of current - enabling the power section to crank out its rated wattage with immediate response and tight authority.

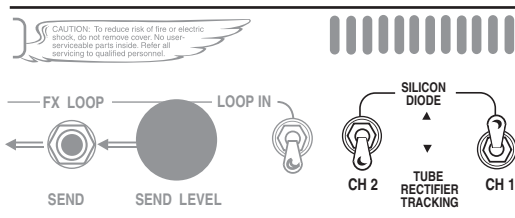

**TUBE TRACKING** would likely be the choice for single note soloing where each note morphs through the vowel sounds as the dynamic content changes from attack to decay. The **SILICON DIODES** will keep bass frequencies tight and track better at extreme preamp gain settings, especially when detuned or at higher volumes, and emphasize attack and urgency.

The Switchable Rectifier feature is a huge part of the success of our entire *Dual Rectifier* line and has elevated them to their current status as iconic classics.

## A.C. RECEPTACLE:

The removable "Euro" Style A.C. cord that is supplied with your new *Stiletto* makes set-ups and tear-downs after the gig a snap. It also makes de-racking much easier when you wish to remove the unit from a hard wired rack system where all the A.C. cords have been cable-tied in. Additional heavy duty cords are available should you ever need one...simply call us direct and we can ship one directly to you for a nominal charge, plus shipping cost. Make sure the A.C. cord is firmly seated in the **A.C. RECEPTACLE** before powering up the amplifier.

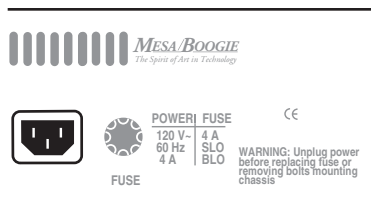

**NOTE: Never alter the three prong power cord in any way.**

## FUSE:

This is the A.C.'s (Alternating Current) main fuse and provides protection from outside A.C. fluctuations as well as power tube failure damage. Should the Fuse blow, replace it with the same rating in a Slo-Blo type package. The domestic U.S. version requires a 4 amp (*Stiletto Deuce*) Slo-Blo fuse. A power tube short or failure is often the cause of a blown fuse...Follow the cold start procedure mentioned in the ON/STANDBY switch section and watch the power tubes as you flip the STANDBY to the ON position.

If a power tube is going bad or is arcing you will see it! Flip the STANDBY switch to Standby immediately and replace the faulty power tube and the fuse if necessary.

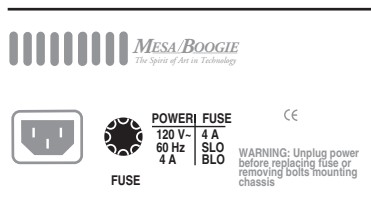

If you see nothing abnormal as you lift the STANDBY switch, it is possible that a power tube shorted temporarily and blew the Fuse. If this is the case it may work again normally. To be safe, you might want to replace it and just the adjacent tube or all power tubes in the "shotgun" troubleshooting tradition and save the replaced set as spares. Spare fuses are a must for the fabled cord bag along with your spare tubes. Always carry both for they could be worth their

weight in gold someday.

That covers the features and functions on the Rear Panel and by now you should be ready to start crafting your dream Tone. If you would like some examples of ways to set the modes in your *Stiletto* for different applications, you may find the following SAMPLE SETTINGS helpful.

We wish you a lifetime of amazing and inspirational Tone from your new musical instrument and our hope is that it takes you to new and exciting places on your musical journey.

# FACTORY SAMPLE SETTINGS

## SAMPLE #1. Skinny Clean / Grinding Tight Crunch Clean

Ch 1 Diodes    Ch 2 Diodes

Control panel for Sample #1. Settings: POWER (ON), STANDBY (ON), SPONGY (BOLD), OUTPUT (SOLO). CH 1: 100 W, 50 W, FTSW, MASTER, PRESENCE, BASS, MID, TREBLE, GAIN. CH 2: 100 W, 50 W, FTSW, MASTER, PRESENCE, BASS, MID, TREBLE, GAIN. FAT CLEAN, TITE CLEAN, CRUNCH, CRUNCH, TITE GAIN, FLUID DRIVE, FT.SW, INPUT.

## SAMPLE #2 Big Clean / Bigger Lead

Ch 1 Diodes    Ch 2 Tube Rectifier

Control panel for Sample #2. Settings: POWER (ON), STANDBY (ON), SPONGY (BOLD), OUTPUT (SOLO). CH 1: 100 W, 50 W, FTSW, MASTER, PRESENCE, BASS, MID, TREBLE, GAIN. CH 2: 100 W, 50 W, FTSW, MASTER, PRESENCE, BASS, MID, TREBLE, GAIN. FAT CLEAN, TITE CLEAN, CRUNCH, CRUNCH, TITE GAIN, FLUID DRIVE, FT.SW, INPUT.

## SAMPLE #3 Brown Crunch / Vintage Lead

Ch 1 Tube Rectifier    Ch 2 Tube Rectifier

Control panel for Sample #3. Settings: POWER (ON), STANDBY (ON), SPONGY (BOLD), OUTPUT (SOLO). CH 1: 100 W, 50 W, FTSW, MASTER, PRESENCE, BASS, MID, TREBLE, GAIN. CH 2: 100 W, 50 W, FTSW, MASTER, PRESENCE, BASS, MID, TREBLE, GAIN. FAT CLEAN, TITE CLEAN, CRUNCH, CRUNCH, TITE GAIN, FLUID DRIVE, FT.SW, INPUT.

## SAMPLE #4 Brit Crunch / Mod. Lead

Ch 1 Diodes    Ch 2 Diodes

Control panel for Sample #4. Settings: POWER (ON), STANDBY (ON), SPONGY (BOLD), OUTPUT (SOLO). CH 1: 100 W, 50 W, FTSW, MASTER, PRESENCE, BASS, MID, TREBLE, GAIN. CH 2: 100 W, 50 W, FTSW, MASTER, PRESENCE, BASS, MID, TREBLE, GAIN. FAT CLEAN, TITE CLEAN, CRUNCH, CRUNCH, TITE GAIN, FLUID DRIVE, FT.SW, INPUT.

## SAMPLE #5 Flat Out

Ch 1 Diodes    Ch 2 Diodes

Control panel for Sample #5. Settings: POWER (ON), STANDBY (ON), SPONGY (BOLD), OUTPUT (SOLO). CH 1: 100 W, 50 W, FTSW, MASTER, PRESENCE, BASS, MID, TREBLE, GAIN. CH 2: 100 W, 50 W, FTSW, MASTER, PRESENCE, BASS, MID, TREBLE, GAIN. FAT CLEAN, TITE CLEAN, CRUNCH, CRUNCH, TITE GAIN, FLUID DRIVE, FT.SW, INPUT.

# FACTORY SAMPLE SETTINGS

## SAMPLE #6 Spankin Clean / Howling Lead

**Ch 1 Diodes    Ch 2 Tube Rectifier**

Control panel for Sample #6. The STILETTO TRIDENT logo is centered. On the left, there are four switches: POWER (ON), STANDBY (ON), SPONGY (BOLD), and OUTPUT (SOLO). The output knob is set to approximately 1/4. In the center, there are two channel selector knobs (CH 1 and CH 2) and a footswitch (FTSW). The right side features seven knobs: MASTER, PRESENCE, BASS, MID, TREBLE, and GAIN. The FAT CLEAN switch is set to CLEAN. The CRUNCH switch is set to CRUNCH. The TITE switch is set to GAIN. The FT.SW and INPUT knobs are also present.

## SAMPLE #7 Detuned Rhythm

**Ch 1 Diodes**

Control panel for Sample #7. The STILETTO TRIDENT logo is centered. On the left, there are four switches: POWER (ON), STANDBY (ON), SPONGY (BOLD), and OUTPUT (SOLO). The output knob is set to approximately 1/4. In the center, there are two channel selector knobs (CH 1 and CH 2) and a footswitch (FTSW). The right side features seven knobs: MASTER, PRESENCE, BASS, MID, TREBLE, and GAIN. The FAT CLEAN switch is set to CLEAN. The CRUNCH switch is set to CRUNCH. The TITE switch is set to GAIN. The FT.SW and INPUT knobs are also present.

## SAMPLE #8 Burning Solo

**Ch 2 Tube Rectifier**

Control panel for Sample #8. The STILETTO TRIDENT logo is centered. On the left, there are four switches: POWER (ON), STANDBY (ON), SPONGY (BOLD), and OUTPUT (SOLO). The output knob is set to approximately 1/4. In the center, there are two channel selector knobs (CH 1 and CH 2) and a footswitch (FTSW). The right side features seven knobs: MASTER, PRESENCE, BASS, MID, TREBLE, and GAIN. The FAT CLEAN switch is set to CLEAN. The CRUNCH switch is set to CRUNCH. The TITE switch is set to GAIN. The FT.SW and INPUT knobs are also present.

## SAMPLE #9 Blues Breakin'

**Ch 1 Diodes    Ch 2 Diodes**





Control panel for Sample #9. The STILETTO TRIDENT logo is centered. On the left, there are four switches: POWER (ON), STANDBY (ON), SPONGY (BOLD), and OUTPUT (SOLO). The output knob is set to approximately 1/4. In the center, there are two channel selector knobs (CH 1 and CH 2) and a footswitch (FTSW). The right side features seven knobs: MASTER, PRESENCE, BASS, MID, TREBLE, and GAIN. The FAT CLEAN switch is set to CLEAN. The CRUNCH switch is set to CRUNCH. The TITE switch is set to GAIN. The FT.SW and INPUT knobs are also present.



## SAMPLE #10 Straight Up





**Ch 1 Tube Rectifier    Ch 2 Tube Rectifier**



Control panel for Sample #10. The STILETTO TRIDENT logo is centered. On the left, there are four switches: POWER (ON), STANDBY (ON), SPONGY (BOLD), and OUTPUT (SOLO). The output knob is set to approximately 1/4. In the center, there are two channel selector knobs (CH 1 and CH 2) and a footswitch (FTSW). The right side features seven knobs: MASTER, PRESENCE, BASS, MID, TREBLE, and GAIN. The FAT CLEAN switch is set to CLEAN. The CRUNCH switch is set to CRUNCH. The TITE switch is set to GAIN. The FT.SW and INPUT knobs are also present.





# PERSONAL SETTINGS PAGE



ON ON BOLD SOLO   CH 1 100 W 50 W  MASTER PRESENCE BASS MID TREBLE GAIN FAT CLEAN TITE CLEAN II   CRUNCH CRUNCH FT.SW INPUT TITE GAIN FLUID DRIVE





POWER STANDBY SPONGY OUTPUT  CH 2 100 W 50 W 



ON ON BOLD SOLO   CH 1 100 W 50 W  MASTER PRESENCE BASS MID TREBLE GAIN FAT CLEAN TITE CLEAN II   CRUNCH CRUNCH FT.SW INPUT TITE GAIN FLUID DRIVE





POWER STANDBY SPONGY OUTPUT  CH 2 100 W 50 W 



ON ON BOLD SOLO   CH 1 100 W 50 W  MASTER PRESENCE BASS MID TREBLE GAIN FAT CLEAN TITE CLEAN II   CRUNCH CRUNCH FT.SW INPUT TITE GAIN FLUID DRIVE

POWER STANDBY SPONGY OUTPUT  CH 2 100 W 50 W 

ON ON BOLD SOLO   CH 1 100 W 50 W  MASTER PRESENCE BASS MID TREBLE GAIN FAT CLEAN TITE CLEAN II   CRUNCH CRUNCH FT.SW INPUT TITE GAIN FLUID DRIVE

POWER STANDBY SPONGY OUTPUT  CH 2 100 W 50 W 

ON ON BOLD SOLO   CH 1 100 W 50 W  MASTER PRESENCE BASS MID TREBLE GAIN FAT CLEAN TITE CLEAN II   CRUNCH CRUNCH FT.SW INPUT TITE GAIN FLUID DRIVE

POWER STANDBY SPONGY OUTPUT  CH 2 100 W 50 W 

**TUBE NOISE & MICROPHONICS:** You may occasionally experience some form of tube noise or microphonics. Certainly no cause for alarm, this quirky behavior comes with the territory and the Tone. Much like changing a light bulb, you don't need a technician to cure these types of minor user serviceable annoyances and in fact, you'll be amazed at how easy it is to cure tube problems...by simply swapping out a pre-amp or power tube!

First may we suggest that you set the amplifier up on something so that you can get to the tubes comfortably without having to bend down. It also helps to have adequate lighting as you will need to see the tube sockets clearly to swap tubes. **Use caution and common sense when touching the tubes after the amplifier has been on as they may be extremely hot!** If they are hot and you don't want to wait for them to cool off, try grasping them with a rag and also note that the glass down around the bulbous silvery tip is considerably less hot which makes it easier to handle. Gently rock the tube back and forth as you pull it away from its socket.

**DIAGNOSING POWER TUBE FAILURE:** There are two main types of tube faults: shorts and noise. Both large and small tubes may fall prey to either of these problems but diagnosis and remedy is usually simple.

If a fuse blows, the problem is most likely a shorted power tube and shorts can either be mild or severe. In a mildly shorted tube the electron flow has overcome the control grid and excess current flows to the plate. You will usually hear the amp become distorted and begin to hum slightly. If this occurs, quickly look at the power tubes as you switch the amp to STANDBY and try to identify one as glowing red hot. It is likely that two of a pair will be glowing since the "shorted" tube will pull down the bias for its adjacent mates, but one tube may be glowing hotter — and that one is the culprit. The other two are often fine — unless they've been glowing bright red for several minutes.

Because there is no physical short inside the tube (just electrons rioting out of control) merely switching to STANDBY for a few moments then back to ON will usually cure the problem...at least temporarily. Watch the tubes carefully now. Should the problem recur, the intermittent tube will visibly start to over heat before the others and thus it can be identified. It should be replaced with one from the same color batch, shown on its label. Call us and we will send one out to you.

The severe short is not nearly so benign. In the worst cases, a major arcing short occurs between the plate and the cathode with visible lightning inside the glass and a major noise through the speaker. If this is seen to happen, IMMEDIATELY turn the amp to STANDBY. By this time the fuse probably will have blown. Such a short is usually caused by a physical breakdown inside the tube including contaminate coming loose or physical contact (or near contact) between the elements. Replace it and the fuse with the proper slo-blo type and power up the amp using the power up procedure as we described earlier in this manual.

**TUBE NOISE:** Often caused by contamination within in a tube, the culprit can usually be identified, and by lightly tapping on the glass, you will probably hear the noise change. Hearing some noise through the speakers while tapping on the 12AX7's is normal however. And the one nearer the INPUT will always sound louder because its output is being further amplified by the second 12AX7.

The power tubes should be all but quiet when they are tapped. If crackling or hissing changes with the tapping, you have probably found the problem. To confirm a noisy power tube, merely put the *Road King* on Standby, remove it from its socket and turn it back on. It will cause no damage to run the *Road King* briefly with one power tube missing. You may notice a slight background hum, however, as the push-pull becomes unbalanced. Whenever you are trying to diagnose a suspect tube, keep your other hand on the POWER and STANDBY switches ready to shut them off instantly in the unlikely case you provoke a major short.

If you think you've located a problem tube but aren't sure, we recommend substituting the suspect with a new one just to be sure of your diagnoses. You will be doing yourself and us a big favor by just following the simple guidelines previously mentioned regarding tube replacement. You'll probably be successful with much less effort than is required to disconnect everything and haul the unit to a technician who will basically perform the same simple tests. If the tubes are still within their six-month warranty period, we will happily send you a replacement. Just note the color designation on the tube label so that we can send you the appropriate match.

**DIAGNOSING PRE-AMP TUBE PROBLEMS:**

Because your amplifier is an all tube design, it is quite possible that you will at some point experience minor pre-amp tube noise. Rest assured - this is no cause for alarm and you can take care of the problem yourself in a matter of minutes by simply swapping tubes.

Let us begin by saying; It is a "very good" idea to keep at least a couple of spare pre-amp tubes on hand at all times to insure uninterrupted performance. These minor pre-amp tube problems can take many forms but can generally be described in two categories: Noise and Microphonics. Noise can be in the form of crackling, sputtering, white noise/hiss and/or hum. Microphonic problems usually appear in the form of a ringing or high pitched squealing that gets worse as the gain or volume is increased thus are more noticeable in the higher gain "HI" modes. Microphonic problems are easily identified because the problem is still present even with the instruments' volume off or unplugged altogether - unlike pick-up feedback which ceases as the instrument is turned down. Microphonic noise is caused by mechanical vibration and shock: think of banging a microphone around and you'll understand where the word came from.

The best way to approach a pre-amp tube problem is to see if it occurs only in one specific mode or channel. This should lead you to the tube needing replacement. Then all that remains is to swap the suspect tube for a known good performer. If you cannot narrow down the trouble to a specific mode or channel, the problem may be the small tube that drives the power tubes which is operational in all modes and channels. Though rare, a problem with the driver tube would show up in all aspects of performance - so if you can't narrow the problem down to being mode or channel specific, you may want to try replacing the driver tube. Driver problems generally show themselves in the form of crackling or hum in all modes of performance and/or weak overall output from the amplifier. Occasionally an anemic driver tube will cause the amplifier to sound flat and lifeless, but this is somewhat uncommon, as worn power tubes are a more likely suspect for this type of problem.

Sometimes making the diagnosis is more trouble than it's worth and it's faster and easier to merely replace the small pre-amp tubes ONE AT A TIME with a replacement known to be good. But MAKE SURE you keep returning the tubes to their original socket until you hit the one that cures the problem. You'll notice that tubes located nearer to the INPUT jack always sound noisier...but this is because they are at the start of the chain and their noise gets amplified over and over by the tubes that follow. The tube that goes into this "input socket" (usually labeled V1) needs to be the least noisy of the bunch. The tube that goes at the end of the preamp chain - just ahead of the power tubes - can be quite noisy without causing any problem at all. The tubes in your amp have already been located in the most appropriate sockets and this is why you should NEVER pull them all out at once and ALWAYS swap them one at a time. ALWAYS return a perfectly good tube to its original socket. Also it's a good idea to put the amp on STANDBY when swapping tubes to reduce the heat build up in the tubes themselves and to prevent explosive noises (which can still occur even if you are pulling the tubes away from their sockets gently) from coming through the speaker.

Remember, take your time, be patient and chances are real good that you can fix your amp yourself by finding and replacing the bad tube. It kills us to see someone who has shipped their amp back to us...and all it needed was a simple tube replacement! If you must send back your amp, remove the chassis from the cabinet by unscrewing the four mounting bolts on the bottom top. The chassis then slides back like a drawer and comes out from the back. Remove the big power tubes and mark them according to their location from left to right 1, 2 etc. They need to be wrapped separately with plenty of wadded up newspaper around them and put in a smaller box within the larger carton. Remove the Rectifier tubes and wrap them also. You can leave the preamp tubes in or remove them and wrap them separately being sure to label their location. (See Tube Task Chart.)

To wrap the chassis, use plenty of tightly wadded up newspaper so there is at least six inches of "crush space" between the chassis and the cardboard box. Bubble wrap also works well, but please DON'T use styrene peanuts - they will shift during transit and get lodged inside your electronics as well as allowing your amp to end up at the bottom of the box unprotected and possibly damaged.

Pre-amp tubes don't normally wear out as a rule. Therefore, it is not a good idea to change them just for the sake of changing them. If there isn't a problem - don't fix it. If there is no result from your substitutions, it may be possible that you have more than one problematic tube. Though rare, this does happen and though it makes the troubleshooting process a little more intimidating, it is still possible to cure the problem yourself.

**NOTE:** *It is normal to hear a slight metallic ringing sound when tapping on the preamp tubes. As long as the tube does not break into oscillation or start crackling or any other form of bizarre noise, it is considered normal and functional.*



**BIAS ADJUSTMENT:** (Part of a continuing series)

An Article written by Randall Smith that we thought you might find interesting.

Here's a question we often hear:

"Why doesn't *Mesa* put bias adjustments in their amplifiers?"

Well, there's a short answer and a long answer to this question.

The short answer is that during my 12 years of repairing Fenders, one of the most frequent problems I saw was bias controls that were either set wrong or that had wandered out of adjustment due to vibration. As any honest tech will tell you, there's lot's of easy money to be made by sprinkling "holy water" on amplifiers ... uh, what I meant to say is "Your amp needed biasing." See what I mean? What customer is going to argue with that?

It only takes a moment and a volt meter: The Fender diagram shows how: "Adjust this trim pot for - 52 volts." That's it. Nothing more.

Now don't be fooled into thinking that tubes "draw" more or less bias, they don't. The way a bias supply is connected to a tube is akin to a dead end road, it just trails off to nowhere without really completing a circuit. It's a static voltage and regardless of what tube is in the socket — or even if the tubes aren't plugged in at all, it doesn't change the bias voltage a bit.

So the end of the short answer is this: Since a bias supply needs to put out the right voltage and never vary, I wanted to build amplifiers that were individually hard wired to the correct values and NEVER needed adjustment. And for 25 years, that's how *MESA/Boogies* have been built.

Time to change tubes? Just plug our tubes into any one of our amps and you're DONE. No tech needed. NO bills and no BS about biasing. And most important: The bias is RIGHT because it can't change!

Now, you want the long answer? Here's more information on how our hard-wired bias avoids trouble. Please read on.

But first, let's make an important distinction. Our business is designing and building high performance amplifiers. And for this we need tubes whose variance is within a narrow range. Our warehouse is full of rejects ...oh, they work — they just don't perform within our tolerance range. We have a very sophisticated computer - based tube testing system (nicknamed "Robotube") that matches and measures tubes over seven important parameters. It can even predict which tubes are likely to have a shortened lifetime — even though they work perfectly during the test.

Because our business is building quality amps, we can afford to reject a lot of wayward tubes. The guys you hear complaining because *Boogies* don't have bias adjusters are primarily in the business of selling tubes - not amps. They don't want to throw away 30 percent of their inventory, so they promote the idea that tubes outside our parameters can be used to "customize" amplifiers and they criticize us because our amps can't be adjusted to accommodate their out-of-*MESA* tolerance tubes.

Now you might be thinking, "But I thought you just said that tubes don't "draw" bias, therefore they don't effect the bias supply and thus it doesn't need to be adjustable." When you set the bias (whether it's by selecting the right resistors, as we do, or adjusting a trimmer — which is quicker) what you are doing is establishing the correct amount of idle CURRENT that flows through the power tubes. But you can't adjust the current directly, you can only change it by adjusting the amount of bias VOLTAGE that goes onto the tubes'

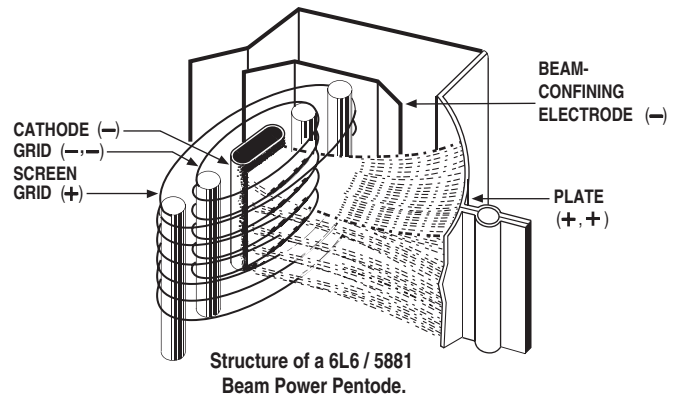

**BIAS ADJUSTMENT:** *(Continued)* control grids. Voltage and current are NOT the same. Current is the AMOUNT of electricity, the “quantity” — and is measured in amperes. Voltage is the degree of electric charge — like the “pressure” to use the old water analogy. Let me illustrate how different voltage and current are:

When you scrape your feet across a carpeted floor in dry, wintery conditions, your body can become charged with 50,000 to 100,000 volts of static electricity. And when you reach for the door knob, a spark jumps and you feel it! The voltage is super high but the current (measured in micro-amps) is tiny - otherwise you would die from electrocution.

Contrast this with your car battery, which puts out a mere 12 volts. You can lay your hands right across the terminals and not feel a thing. Yet the amount of current available can run to several hundred amperes .. enough to turn over a cold engine and get it started.

So current and voltage are two totally separate electrical parameters — though when you multiply them together, you get POWER, which is measured in watts.

When you set the bias of an amplifier, you are adjusting the static VOLTAGE at the control grid of the tube in order to produce a desired amount of idle CURRENT flowing to the tube’s plate. A small change in grid voltage, produces a large change in the amount of current flowing — and that’s basically how a tube works. Say that again because it’s super important: A small change in voltage at the grid causes a large change in current flowing to the plate. See, that’s the essence of amplification: A small change causing a large change. And here it’s a small voltage change causing a large current change.

The bias conditions are what determines how much current flows through the big power tubes when you’re not playing. And what drives your speakers is fluctuations in that current flow when you ARE playing. If the amount of current increases and decreases 440 times per second, then you’ll hear an A note. If the fluctuations in current flow are large and still at 440 per second, you’ll hear an A that is LOUD!

But for purposes of biasing, it’s the amount of “plate current” flowing with no signal applied that’s important. Unfortunately current is hard to measure because the circuit must be interrupted — as in “cut the wire” — and the meter spliced “in series” with the broken circuit. But measuring VOLTAGE is easy. It is not necessary to interrupt the circuit because a voltage reading can be taken in PARALLEL with the circuit intact.

Thus, as a matter of convenience, most bias settings are given in volts at the grid ... even though current through the plate is the important factor. In fact plate current is so inconvenient (and dangerous) to measure that Fender doesn’t even state what the correct value should be. They only give the grid voltage that will produce that current. (That’s the minus 52.) But that only happens if the tubes being used are “in spec.”

As long as the tubes ARE “in spec”, the right bias voltage will always give the correct plate “CURRENT” — but then there’s no need for the bias voltage to be adjustable!

If the tubes are NOT in spec, then the only proper way to re-set the bias is to cut the circuit and measure the current while adjusting the bias ... but no manufacturer I know even STATES the desired current value! Be that as it may, when the original bias voltage is altered far enough, it will compensate for the tube’s abnormal performance and the correct amount of idle current flow may then be restored. Clearly this is something most repair techs should not attempt.

Some newer amps have LED indicators connected to the circuit which will turn on when the right threshold of current flow has been reached. This is an improvement, and almost worthy if you’re willing to except resistors and lights added into your amplifier’s audio path — which we aren’t.

The other “advantage” of this system is that it allows some amp manufacturers to avoid matching their power tubes. The thinking is that adjusting the bias to each tube separately eradicates the inherent differences between the tubes by insuring that the same current flows through each one.

**BIAS ADJUSTMENT:** *(Continued)* Again, this has some merit .. but it's still not as good as using tubes that are matched in the first place because compensating for the mis-match causes the push-pull circuit itself to become unbalanced. Two wrongs don't really make a right.

Some of the other recommended biasing, "methods" — such as -".. tubes running red hot, increase the bias .. sounds harsh and runs too cool, turn it down ..." are guesswork at best. Luckily, one of the great things about tube amps is that they can usually stand some abuse without causing any real harm ... at least not immediately. But don't these alterations imply that you are second-guessing the amp designer and that there's a better set of operating conditions that the designer missed but the tube sellers have discovered?

Now some players may like the sound of their amp altered by tubes with extreme characteristics and with the bias set to help compensate. But often it is the mere novelty of change that they're really responding to and when the amp goes back to the proper original way, we've seen them be far happier still!

Because every part in every one of our designs has been meticulously evaluated, compared and stressed over — no matter how seemingly insignificant it might be. And with every design we look for a "sweet spot" where all the parameters — including the bias — come together to give the best sonic performance, consistently and reliably. Every part and voltage is important — yet no one complains that these other parameters aren't available for tinkering.

Consider our patented *Simul-Class* circuitry where there are two different bias voltages used for separate pairs of power tubes ... and changing one voltage also changes the other. Great care goes into getting this just right and we think we'd be asking for trouble to have it adjustable for the world to play with ... unless you like paying to have your amp messed up. Sorry, I meant to say, "Uh, ... your amp needed biasing."

If that doesn't appeal to you, then merely plug a matched set of *MESA* tubes into one of our amps and you're ready for tone. Guaranteed. You'd be amazed at the number of service calls we field every day that lead to a diagnosis of out-of-tolerance, non-spec tube problems. To think these would be prevented by including a bias adjustment is something of an insult to you and us. If you put the wrong size tires on your car, do you think changing the pressure will make them right?

Please, don't think this is a blanket indictment of the other guys selling tubes — it isn't. And their tubes aren't all bad either. It just doesn't make sense to pay more of your hard earned cash for tubes that were probably made in the same Russian or Chinese factory and which have the possibility of being outside the performance window we select for your amp. And it pains us to hear the hype and mystique built up around biasing when twenty-five years of evidence affirms our decision to make bias circuits that "never need adjustment". How much money and trouble that has saved *MESA/Boogie* players you couldn't estimate.

Our rigorously tested and hand selected tubes are available at your nearest *MESA/Boogie* Pro Center or from us directly. Nobody offers better price, quality or warranty than we do ... so why swerve?

Next time we'll talk about our part in developing the great Sylvania STR 415 type 6L6 and how we're on the verge of seeing something fairly close reappear on the market. Remember, we still have some of these super rugged mondo-bottles available for older amps — *Boogies* only please! Until then, Relax, Breathe and Nourish your soul!

Cheers!

*MESA/Boogie Ltd.*

# SPEAKER IMPEDANCE MATCHING & HOOK-UP GUIDE:

**IMPEDANCE:** Wiring up speakers to provide the most effective load and making sure that all of them are in phase will help in creating the best sound possible. This is not too difficult, as long as you understand a few things about loading and how to connect your speakers to provide an optimal resistive load.

*MESA/Boogie* amplifiers can handle 4 and 8 ohms effectively. Never run below 4 ohms in a tube amplifier unless you are absolutely certain that the system can handle it properly; this can cause damage to the Output transformer. A few amplifiers can handle 2 ohms effectively without damaging them ( for example the *MESA'S Bass 400+* ). You can always have a higher resistance ( 16 ohms, for example ) without damaging results, but too low of a resistance will likely cause problems.

**MIS-MATCHING:** When running a higher resistance ( for example: 8 ohm output into 16 ohm cabinet ), a slightly different feel and response will be eminent. A slight mismatch can provide a darker smoother tone with a little less output and attack. This response is a result of the amplifier running a bit cooler. Sometimes when using more than one cabinet a mismatch will be the only option.

**WHAT IS MY CABINETS IMPEDANCE:** If you have only a single speaker, you just match that single speakers impedance to the amplifier, and you are done. In many cases, you will have a number of speakers, and then you must calculate the "load" that the amplifier will need to support. There are generally three ways to wire multiple speakers together. They are as follows:

**SERIES:** When you wire ( hook-up ) speakers in Series, the speakers resistance ( as measured in ohms ) is additive - i.e. putting two 8 ohm speakers in Series results in a 16 ohm load.

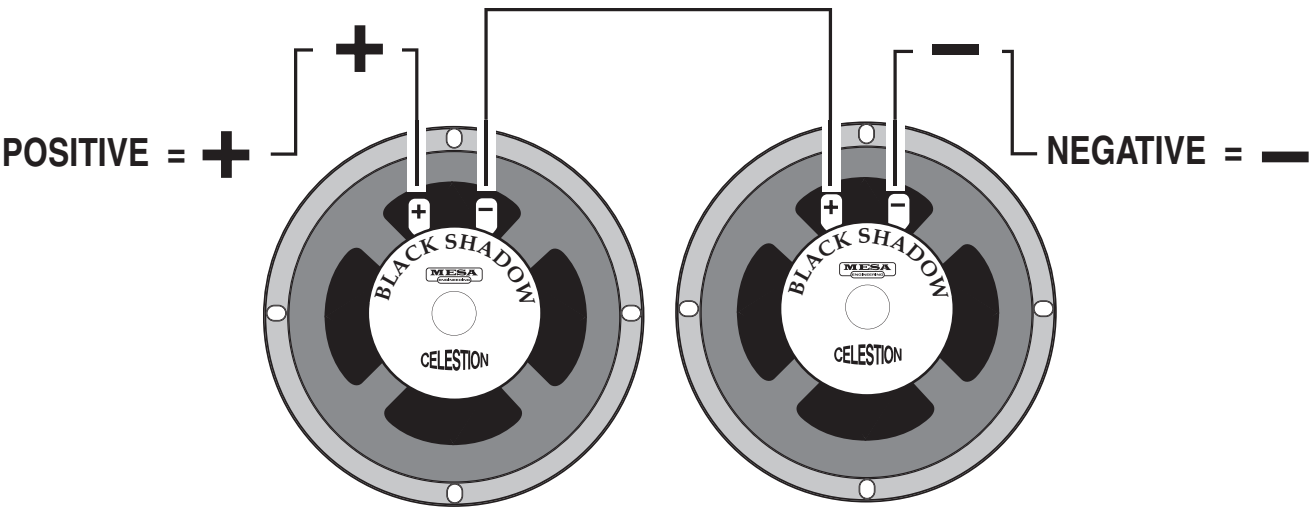

Speaker A = 8 Ohms

Speaker B = 8 Ohms

**SERIES:** Connect the Negative side of Speaker A to the Positive side of Speaker B

## SPEAKER IMPEDANCE MATCHING & HOOK-UP GUIDE: (Continued)

**PARALLEL:** When wiring in parallel, the resistance of the speakers decreases. Two 8 ohm speakers wired in ( hooked-up ) Parallel results in a 4 ohm load. It's easy to calculate the effect of a resistive load when all the speakers are all the same resistance. It is really not suggested to wire different resistive load values in Parallel ( 8 and 4, 16 and 8 etc. ) The formula for figuring the total impedance in Parallel is the multiplication of the two loads divided by the sum of the two loads - i.e. putting two 8 ohm speakers in Parallel results in a 4 ohm load. Connect the Positive side of Speaker A to the Positive side of Speaker B - Connect the Negative side of Speaker A to the Negative side of Speaker B.

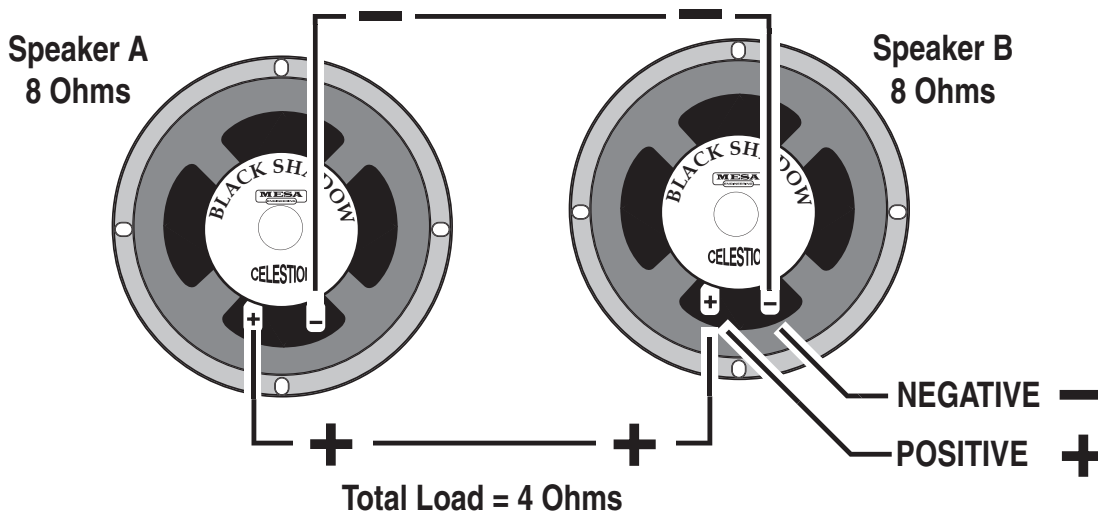

**COMBINATION OF SERIES & PARALLEL:** This is really just two sets of Series wired speakers connected in Parallel. This is how you maintain a consistent load with multiple speakers. The importance of this is more evident when you have more than one cabinet to connect to your amplifier. This is when you need to figure out the loads and how to wire them up without applying too low of a resistance on the amplifier.

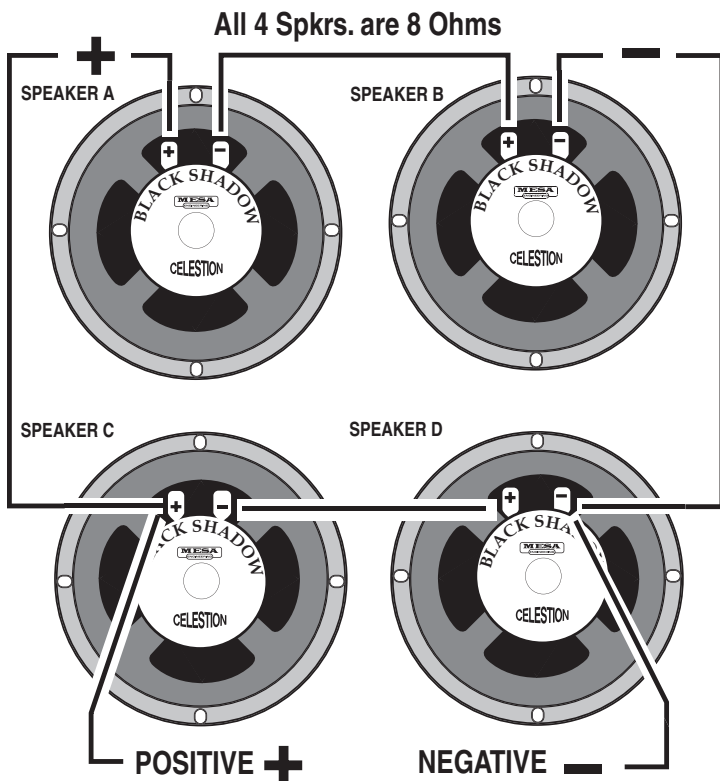

Simply connect the Positive side of Speaker A to the Positive side of Speaker C.

Connect the Negative side of Speaker A to the Positive side of Speaker B. Next, connect the Negative side of Speaker C to the Positive side of Speaker D.

And lastly, connect the Negative side of Speaker B to the Negative side of Speaker D.

4 Eight ( 8 ) Ohm speakers wired in Series Parallel = a Total Load of 8 Ohms.

# WIRING SCHEMES...Amplifier to Speaker Cabinets

6

7

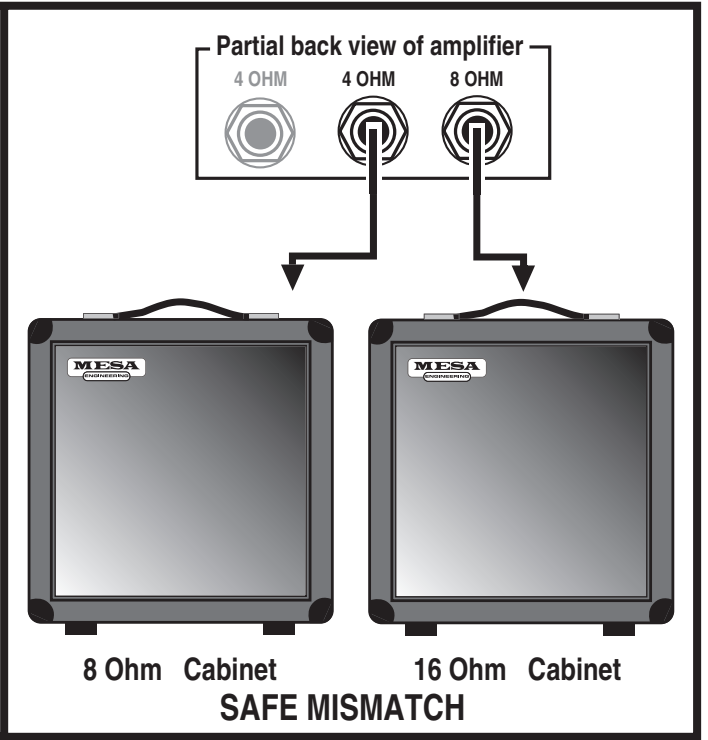
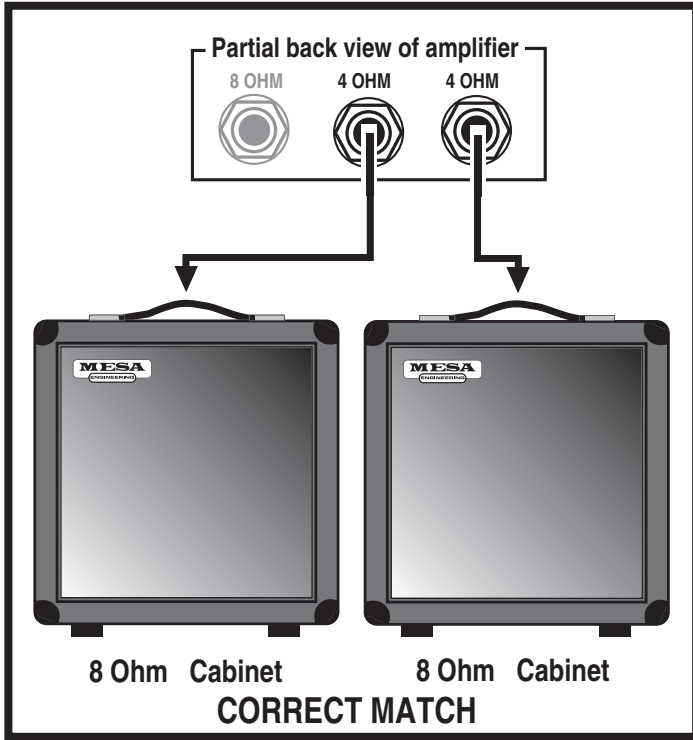

8

9

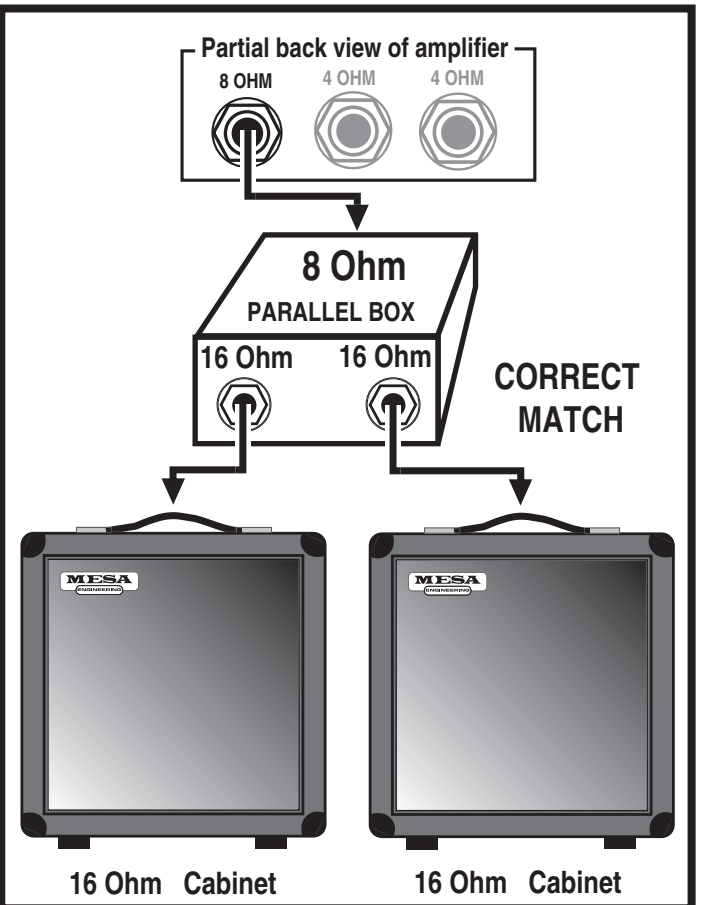
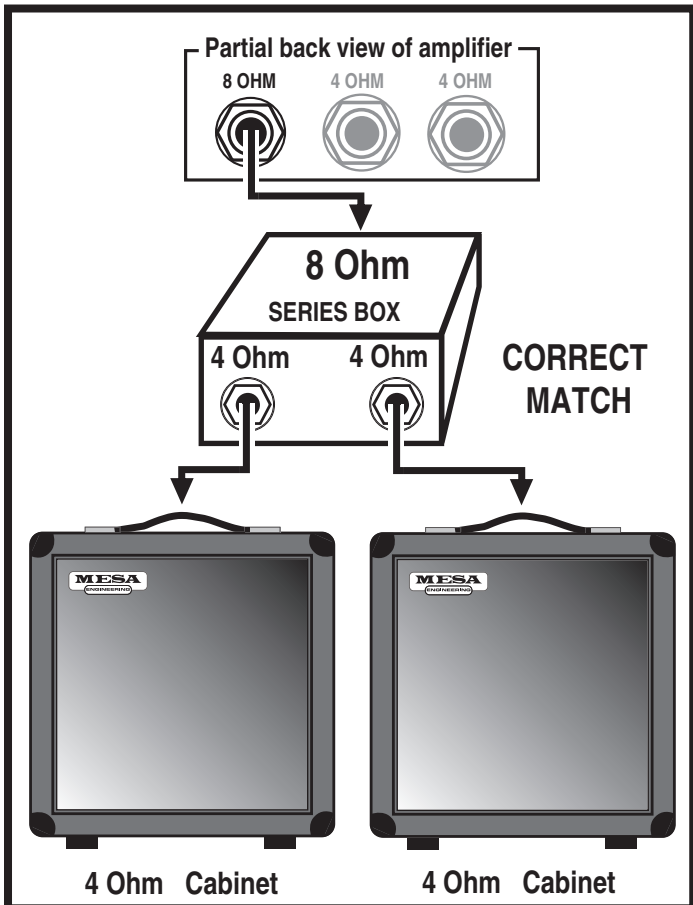

# WIRING SCHEMES...Amplifier to Speaker Cabinets

1

2

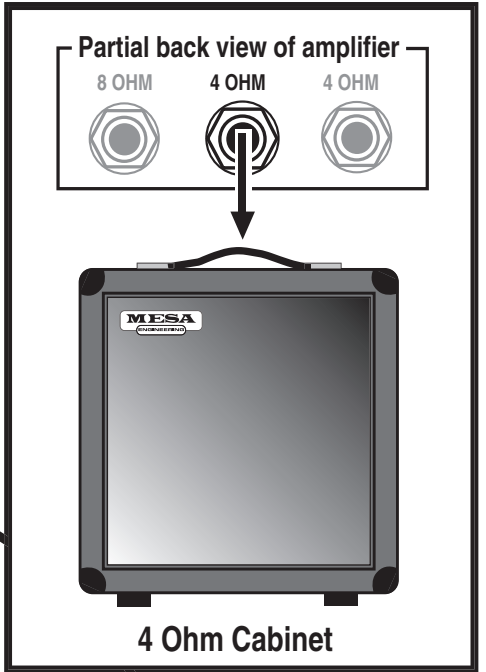
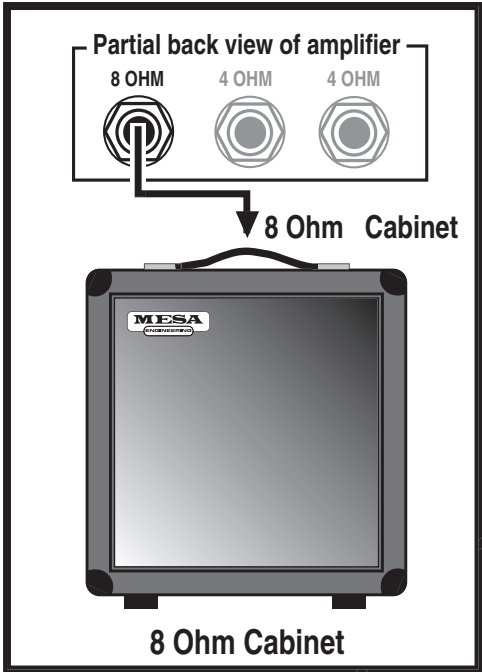

3

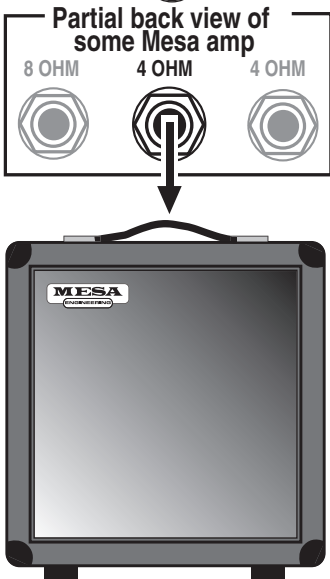

4

5

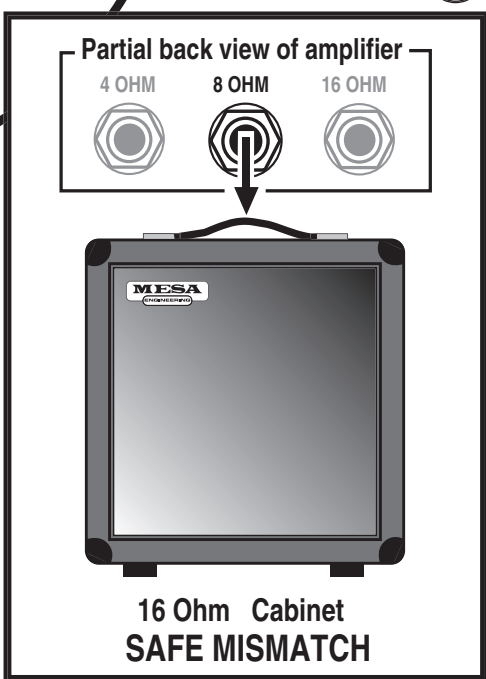
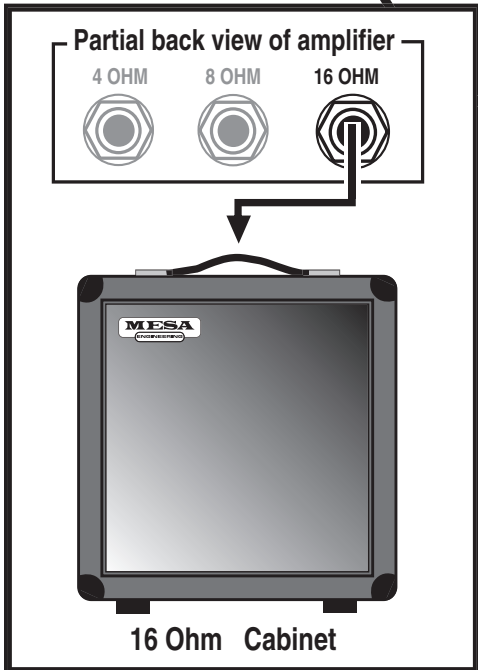

# WIRING SCHEMES...Amplifier to Speaker Cabinets

13

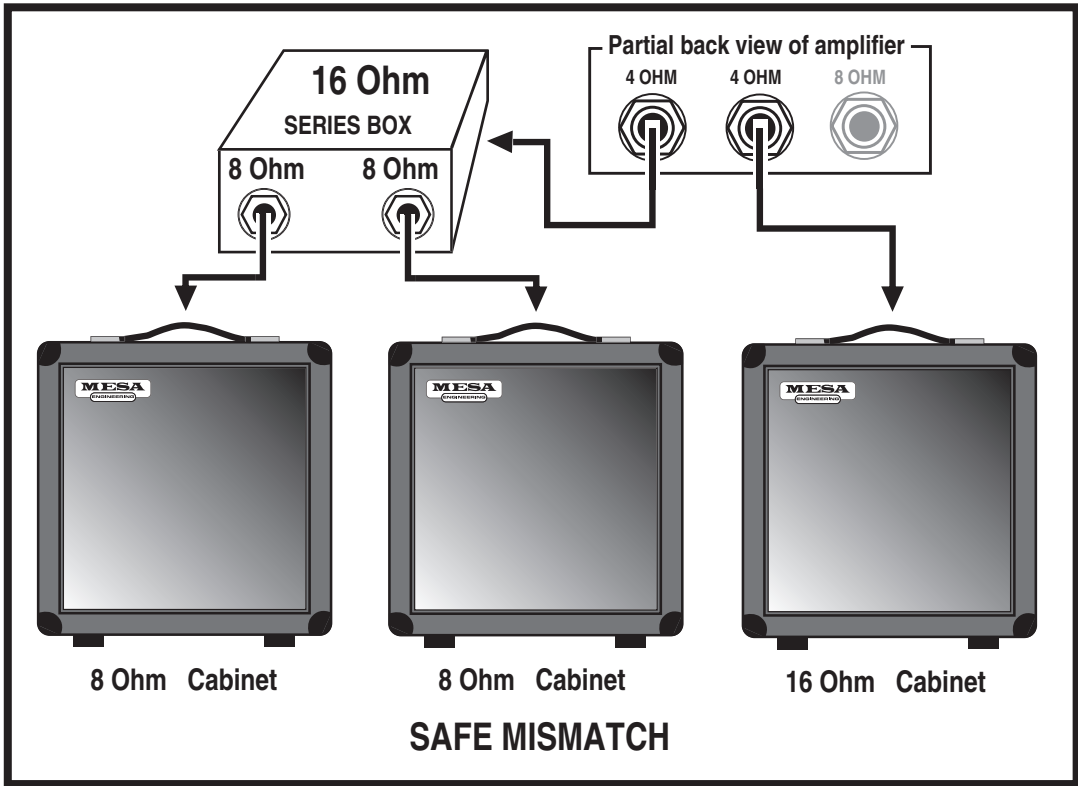

14

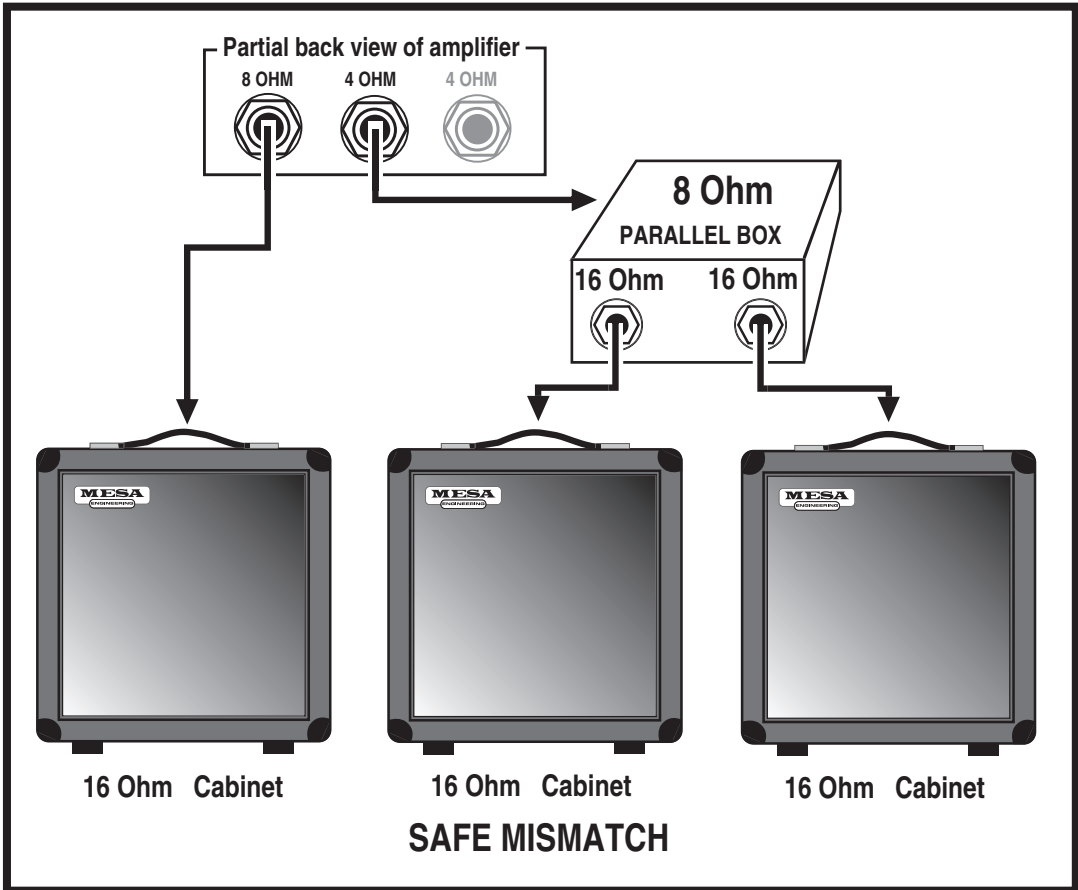



# WIRING SCHEMES...Amplifier to Speaker Cabinets

10

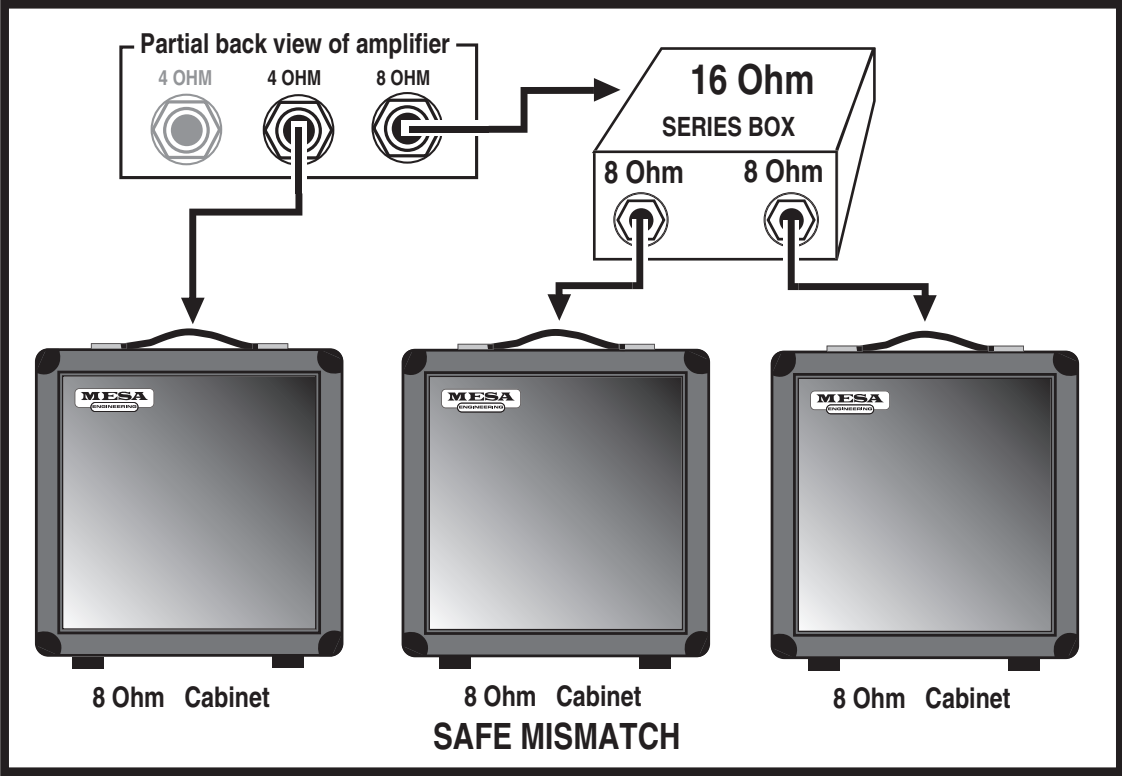

11

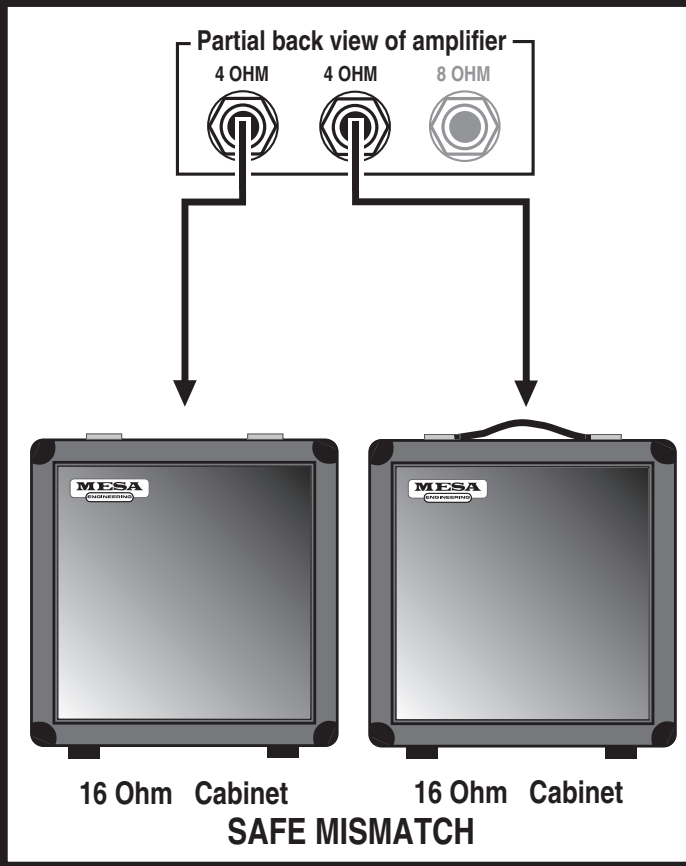

12

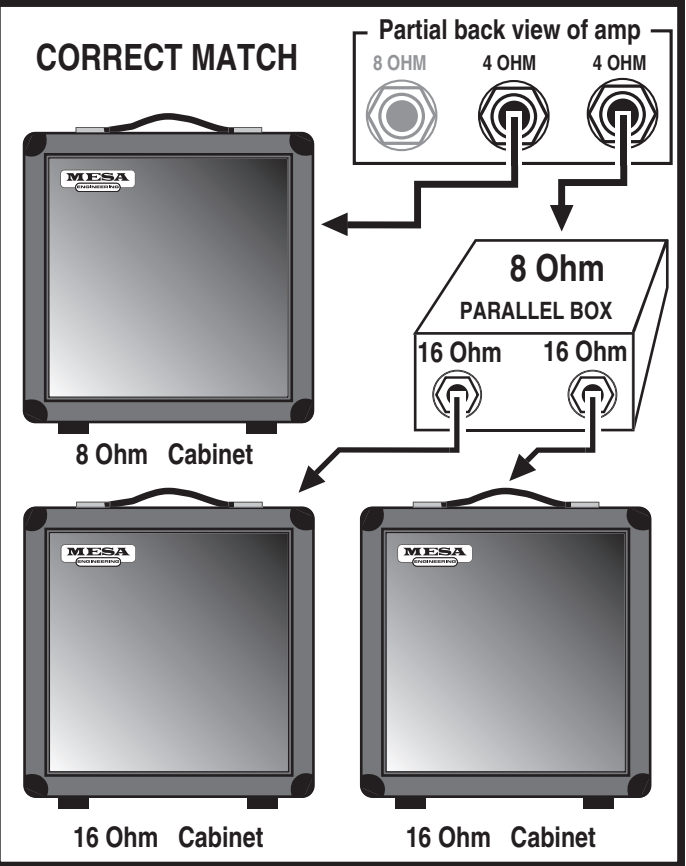

## ON TRIODES, PENTODES & IRISHMEN:

With apologies to Friends and Relatives from the Emerald Isle - who will make their appearance soon enough - the humor which follows is dedicated to the memories of Spec McAuliff and Fae (Rafael) McNally, two of the True Greats.

As their numerical references suggest, the terms Diode, Triode and Pentode indicate the number of elements within the vacuum tube i.e. two, three or five. All tubes also require a filament or heater which is not included in the count. Its purpose is to excite electrons from the cathode coating by raising the temperature such that they are able to boil out of the electron-rich coating material and form a cloud of free electrons in the vacuum space surrounding the cathode.

Although the term filament and heater are often used interchangeably, there are specific differences: A filament is a directly heated cathode where cathode coating is applied directly to the heating element. Examples are 5U4 twin diode rectifier and 300B triode amplifier tubes. A heater, on the other hand, is a heating element which is separate from the cathode and is usually inserted within the tubular cathode sleeve. Examples are 12AX7 twin triode amplifier and 6V6 or EL84 beam power pentode tubes. In all cases this fundamental aspect of each tube's construction is clearly visible, especially when the heating element is glowing red hot.

The cathode, then, would be considered the first numbered element because it is the source of the electrons. The word itself is from the Greek literally meaning completely down, which implies a sense of central origin - like the center of the earth where Tone begins. It might be said that an ecstatic audiophile experiences a positive catharsis, his soul being purified when his system transports him to Audio Nirvana. The only trouble with taking this positive imagery too far is that the cathode is, unfortunately, negative... at least electrically speaking. However this is easily remembered since virtually all musicians and audiophiles have also experienced the more common negative catharsis when they emerge from the emotional rebirth kicking and screaming in rage and frustration.

Once heated, the intrinsically negative electrons are energetic little fellows of almost no mass. Thus they may be accelerated almost instantaneously and will travel through a vacuum a nearly the speed of light. Being of like, negative charge, they tend to repel one another and thus within the electron cloud surrounding the cathode, there is much jostling and elbowing as each one tries to maintain his distance from all the others... unless there is a strong and universal attraction from an outside influence.

Visualize, if you will, a group of sub-atomic Irishmen milling about and in a repellent, negative state of mind. All are scowling and none wants to have anything to do with the other. Now introduce a strong attraction say, a public bar, and you can easily picture an orderly, if rapid movement of the lot in a single direction. This is what happens when a positively charged element called the anode or plate is introduced into the vacuum.

The plate is the large metal element most prominently visible through the glass of an electron tube. It is the outermost element of a tube's structure and it surrounds all the others. The cathode is at the center radiating electrons outwards. As higher and higher positive voltage is applied to the plate, the attraction for the electrons surrounding the cathode is increased and with nothing standing in the way, full uninhibited flow to the plate occurs... sort of like removing the doors and offering free drinks to the crowd of surly Irishmen milling around outside. As electrons flow to the plate, the space charge will continually be replenished by further 'boiling' of the hot, electron-rich cathode as you can easily imagine other Irishmen impatiently taking up the places of those who've gone inside - until the entire village is deserted.

Now, where do they come from and how do they emerge? Well, a grand and elegant lady once showed me how to revive flat champagne: She dropped a raisin into the glass. There was a dramatic and immediate increase in effervescence with the introduction of a cathoding surface. Thousands of tiny bubbles suddenly appeared - and continued to flow from the raisin. Of course the bubbles were made up of gas dissolved in the beverage, but the analogy makes it easy to visualize the loosely bound electrons dissolved in the rich cathode coating as they effervesce from its heated surface.

But back to the electron flow. If the electrons are strongly attracted to a positively charged plate, then it follows that they are strongly repelled by a negatively charged plate and they are. Thus, if an alternating current - such as comes from a transformer - is applied to the plate, electrons will flow only during the times when the plate is positively charged. During periods of negative plate charge, electron flow is stopped and the space charge of electrons remains compressed in the area around the cathode.

**ON TRIODES, PENTODES & IRISHMEN: (Continued)**

Thus a diode tube - one with a cathode and an anode - is mostly used to rectify alternating current into direct current by passing it without restriction, but in one direction only. This also explains why closing time is strictly enforced at Irish pubs: During normal operation, the traffic flow is similarly unimpeded and uni-directional toward the bar and this process rectifies the work-day negativity. It goes without saying that no one leaves as long as the atmosphere around the bar remains positively charged.

**TRIODES:**

This section is a continuing technical treatise on the workings of Irish Pubs but to make it easier for the layman to understand, it is explained in terms of vacuum tube technology. Enter the original bar - free beer and no doors. Well, it turns out that some control over the flow can be a necessary and useful advantage. This led to the invention of those swinging louvered saloon doors which are open at the top and bottom. They are patterned after the control grid of the vacuum tube, which is a loosely wound coil of thin wire located between the cathode and the plate.

In a Triode the plate is always positively charged with high voltage D.C. and even though the grid is blocking the path, those negative electrons can still FEEL the strong attraction - just as the Irishmen can see in through the louvers of the bar doors. They know what pleasures lie beyond, but to get there requires overcoming the negative influences controlling the access. This negative influence is typically called a Bias. In electronic terms that means the grid is supplied with a voltage which is slightly MORE NEGATIVE than the already negative electrons. The more negative the Bias, the more it tends to neutralize the attraction of the plate and repel the electrons back toward the cathode.

The Irish can be similarly charged with Bias, but unless you are Irish yourself, this type of Biasing may be more difficult to understand. The effect is similar though: The more negative the Bias, the more it impedes forward progress. Generally speaking though, the electronic Bias of the grid is easiest to overcome, and for two main reasons: First, the Bias is set - like the bar doors - to allow some passage. Second, the grid is mostly NOT THERE, like the louvered doors which are mostly open spaces. Unlike the plate which is solid, the grid is like a coiled bed spring. It can create a repelling field but mostly it's empty space in between widely separated windings of wire. It's very easy to control the electrons as they pass through the grid's force field: Changing the grid voltage only slightly will have an enormous effect on how much current flows through... and that's what AMPLIFICATION is: a small change in voltage at the grid causing a large change in current flowing to the plate.

The purpose of the louvered bar doors is similar to that of the grid, namely, to give momentary pause while still revealing the promise within. Hesitation mostly gives way to temptation, but there are those few stalwart Irishmen who think twice and decide to come back later. Most just pause slightly then go on through. That is the purpose of the bar doors: to prevent everyone from crowding in all at once - and as the door is made less of a barrier, wider spaces between the louvers, more of the bar's attractive influence is felt outside thus amplifying the customer flow and increasing the crowd at the bar.

**PENTODES:**

Occasionally though, bar doors - even the louvered type - were found to be too effective, and too many customers turned away. Something further was needed to increase the attraction of the bar and overcome the resistance created by the door. Thus the cocktail waitress was invented.

Once again the idea was inspired by the vacuum tube. It had been discovered in some tubes, often large power types, that the distance to the plate was too great to attract enough electrons past the negative influence of the control grid. So another grid coil of fine wire was inserted between the first grid and the plate. This was called the screen grid and carrying a highly positive charge, it functioned as a "bait" for the plate.

In a properly designed power tube such as an EL84 or a 6V6, the windings of the screen grid are precisely aligned to fall in the shadow of the control grid. This way the electrons responding to the pull of the screen grid are lined up in sheets as they pass between windings of the inner control grid... only to find that they have been fooled! Once past the control grid and drawn toward the screen grid, they discover...there's almost nothing there. The path they're on has them aligned to zing straight through the spaces BETWEEN screen grid windings. So rather than a close and personal encounter, they just fly on past - and once they're out that far, there's no stopping them. The influence of the plate takes over and - being solid metal and of the highest positive attraction - it is at this final destination that the electrons congregate.

**PENTODES:** *(Continued)*

Thus the proper cocktail waitress - visible through the louvers - is scantily clad so as to be all the more effective at reinforcing the attractive influence of her bar and by being located in between the door and the bar, she serves as bait to lure customers past the door's negative influence. Once through the door however, it is the rare Irishman who actually comes in personal contact with the cocktail waitress as, for all intents and purposes, she - like the screen grid - turns out to be a vanishing illusion. Yet, having come this far, the solid influence of the bar itself now takes over and attracts the customers to congregate, having happily reached their destination.

If you're still following this and haven't lost track of the count, you'll know we're still one element short of the five needed to make a Pentode. This last part is a pair of beam-confining shields which being negatively charged, serve to direct the flow right toward the plate. This is much the way a short entrance hall to the bar prevents wandering accidentally into the Men's room on the way.

Once at the bar though, the circuit is complete and the process of soul-nourishing works its ritual magic. Biases having been overcome, illusory nightingales having vanished, the spirits truly soar and the once surly Irishmen now are filled with warmth, wit and kindred friendship, enjoying the music and glowing nicely with their heaters on.

With appreciative thanks to the inhabitants of the Land of the Leprechaun, we have now concluded our little diversion into the mechanics of proper bar lay-out.

A feature article by Randall Smith  
Designer / President

# Stiletto "Trident" TUBE TASK CHART

## BACK EDGE OF CHASSIS

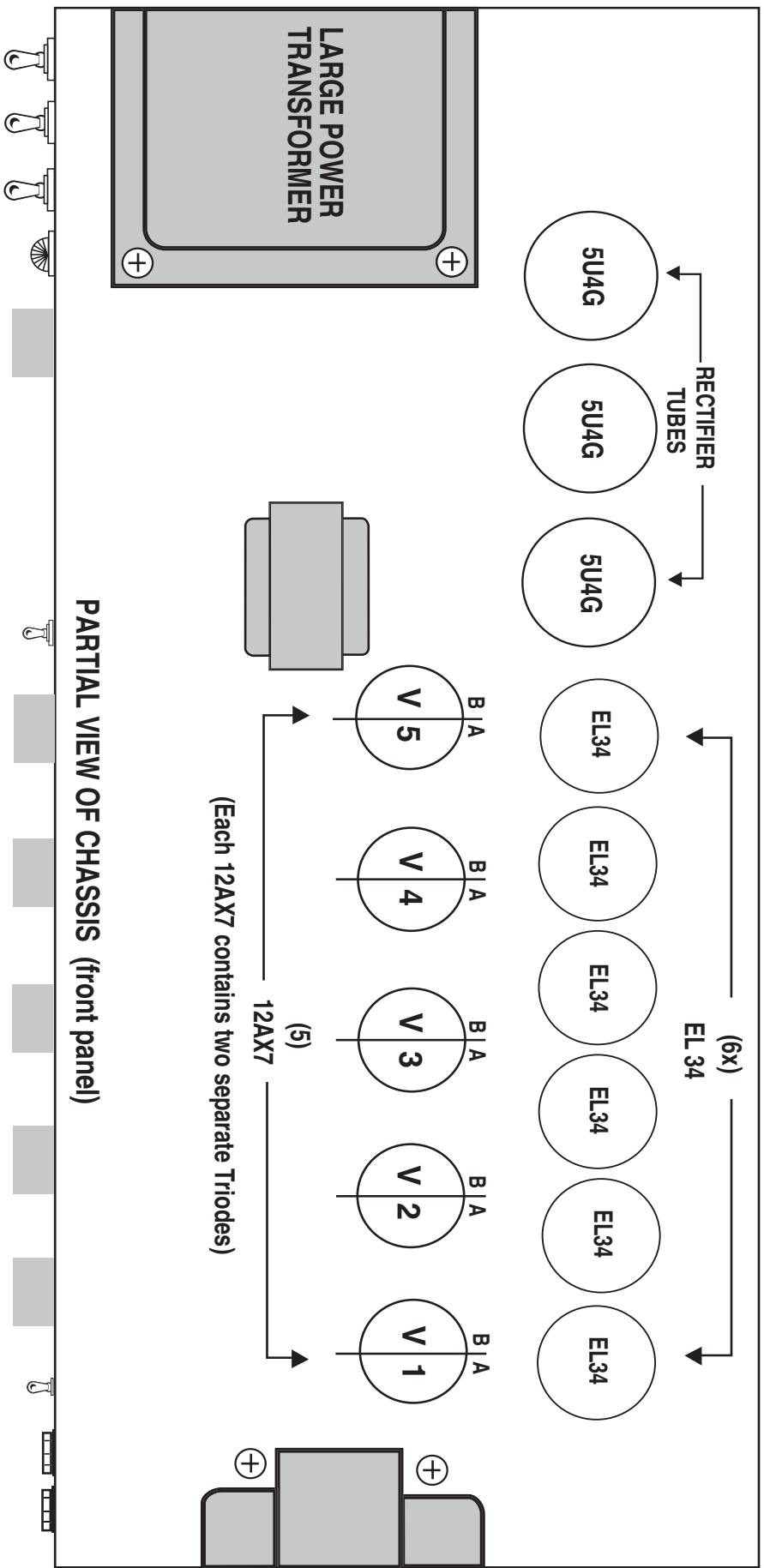

PARTIAL VIEW OF CHASSIS (front panel)

**Description of Tube Functions**

<p><b>V1 A= 2nd Gain Stage</b></p> <p><b>V1 B= Input Stage</b> (all modes except Fluid Drive &amp; Fat Clean)</p> <p><b>V2 A= Input Stage</b> (Fluid Drive &amp; Fat Clean)</p> <p><b>V2 B= 3rd Gain Stage</b></p> <p><b>V3 A= 4th Gain Stage / 2nd Gain Stage Clean Modes</b></p>	<p><b>V3 B= 5th Gain Stage</b></p> <p><b>V4 A= FX Return</b></p> <p><b>V4 B= FX Send</b></p> <p><b>V5 A= Phase Splitter / Driver</b></p> <p><b>V5 B=</b></p>
--	--

# Stiletto "Deuce" TUBE TASK CHART

## BACK EDGE OF CHASSIS

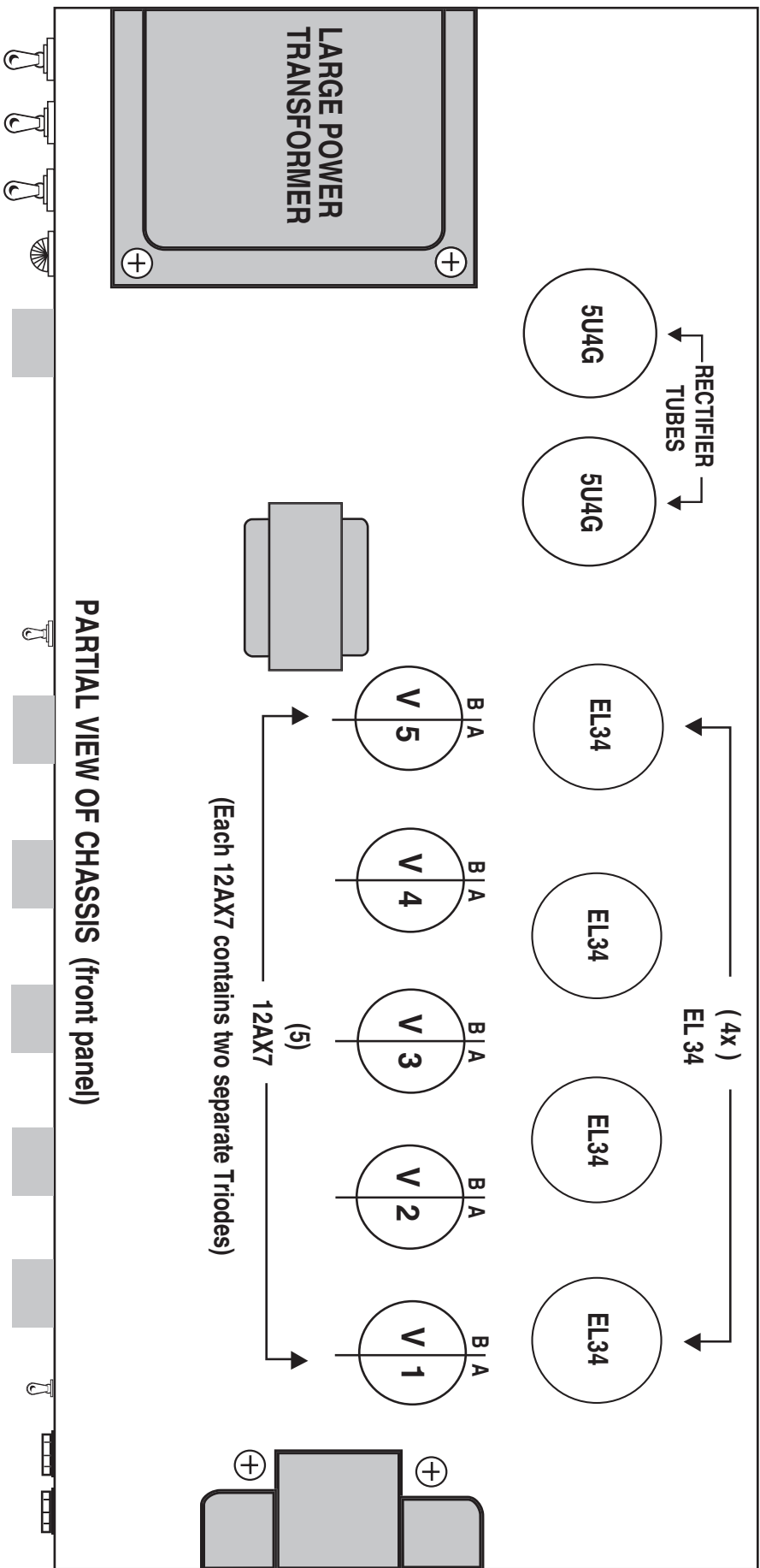

PARTIAL VIEW OF CHASSIS (front panel)

### Description of Tube Functions

- V1 A= 2nd Gain Stage
- V1 B= Input Stage (all modes except Fluid Drive & Fat Clean)
- V2 A= Input Stage (Fluid Drive & Fat Clean)
- V2 B= 3rd Gain Stage
- V3 A= 4th Gain Stage / 2nd Gain Stage Clean Modes
- V3 B= 5th Gain Stage
- V4 A= FX Return
- V4 B= FX Send
- V5 A= Phase Splitter /
- V5 B= Driver

**FRONT PANEL : Stiletto**

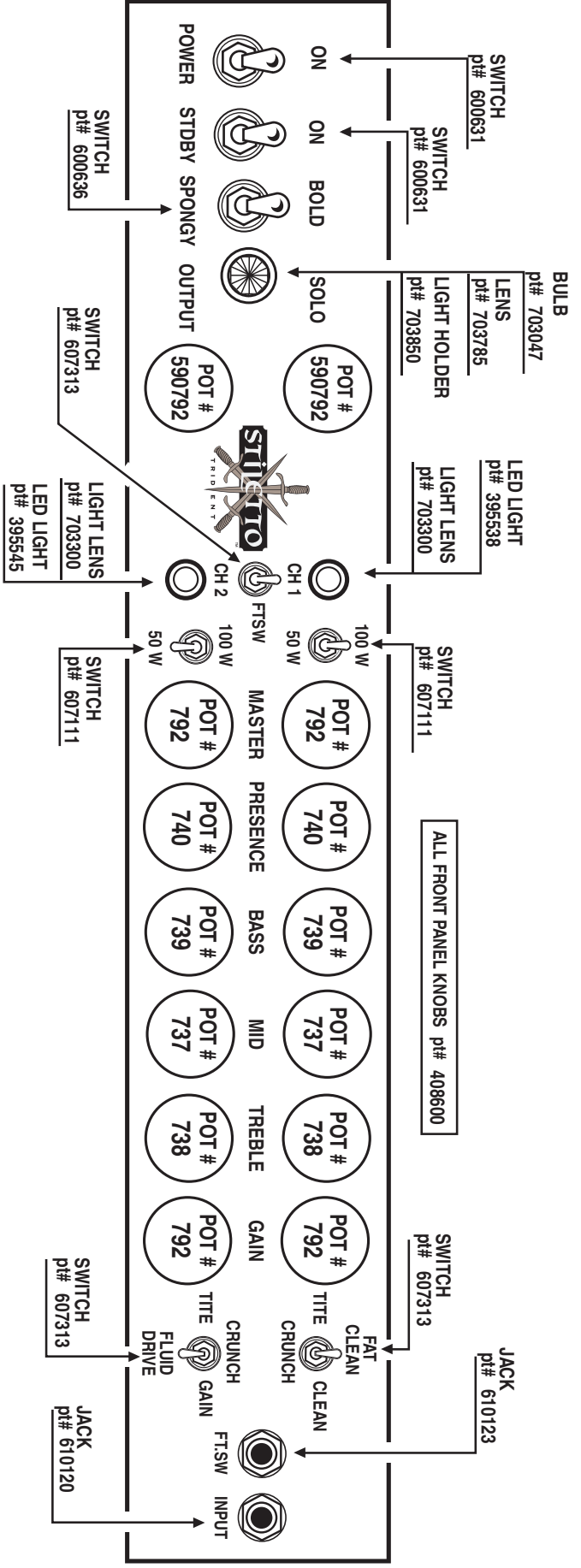

**REAR PANEL : Stiletto**

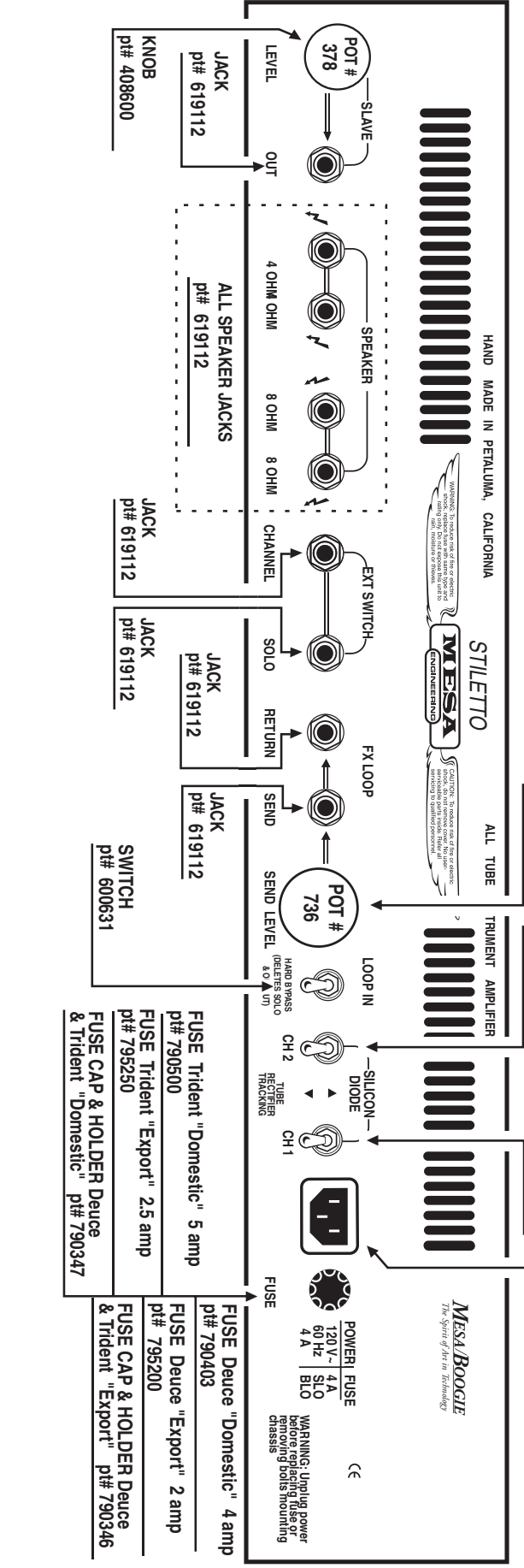





# ***MESA/BOOGIE***

*The Spirit of Art in Technology*

*Thank you for trusting MESA/Boogie to be your amplifier company and we wish you many years of toneful enjoyment from this handbuilt all tube instrument.*



*The Spirit of Art in Technology*



*(707) 778-6565      FAX NO. (707) 765-1503*

*1317 Ross Street Petaluma, CA 94954  
USA*