

MESA/BOOGIE[®]

California
tweed[™]



Owner's Manual

Hello from the tone Farm

Congratulations on your choice of the CALIFORNIA TWEED™ and welcome to the MESA/Boogie® Family! The model you've selected has a deep heritage that combines the best attributes of vintage tube amplification with pioneering innovation to arrive at a new realm of performance. One look at the feature set tells you it's true to its genre, but underneath the hood, while the authenticity has been considered and adhered to where appropriate, it has also been revised and upgraded to provide modern flexibility and a new frontier in power expression. The lineage dates back to our earliest MARK I™ and the very beginnings of guitar amplification that inspired it, while the breakthroughs included reach forward to set a new bar in traditional tone. So feel a sense of pride that you're playing an instrument like no other, an original in every way! Just like you!

Our 50 year commitment to excellence along with our solemn promise to musicians - to treat each as we ourselves would wish to be treated - guarantees you an experience that will make you feel truly justified in your choice. We're confident your new amplifier will have you smiling and inspired within minutes of plugging in for the first time...but what's really gratifying is that you will be finding new and inspiring sounds years after the price of admission has faded from memory and the CALIFORNIA TWEED™ continues to unveil it's true worth.

It's with our sincere thanks for trusting us with your TONE and our best wishes for all your musical endeavors that we welcome you home. Should you ever need assistance or guidance we're here to help. You now have in your hands an instrument of limitless expression. Our hope is that it takes you and your playing to new and unimagined places throughout your musical journey. From all of us here at MESA®...Enjoy!



CONTENTS

IMPORTANT SAFETY INSTRUCTIONS	1
PRODUCT COMPLIANCE INFORMATION	1
OVERVIEW	2
GETTING STARTED	4
INSTANT GRATIFICATION	4
HELPFUL HINTS	4
FRONT PANEL	6
<i>INPUTS</i>	6
<i>GAIN</i>	7
<i>TREBLE</i>	8
<i>MID</i>	8
<i>BASS</i>	9
<i>PRESENCE</i>	10
<i>MASTER</i>	10
<i>REVERB</i>	11
<i>MULTI-WATT™</i>	12
<i>POWER</i>	12
<i>STANDBY</i>	12
<i>COLD START PROCEDURE</i>	13
REAR PANEL	13
<i>POWER OUTLET/AC MAINS SOCKET: (Removable IEC TYPE)</i>	13
<i>FUSE</i>	13
<i>EFFECTS LOOP (SERIES)</i>	13
<i>REV FTSW (REVERB FOOTSWITCH JACK)</i>	14
<i>SPEAKER OUTPUTS</i>	15
FACTORY SAMPLE SETTINGS	16
USER SETTINGS	18
DIAGNOSING PRE-AMP TUBE PROBLEMS	20
SPEAKER IMPEDANCE MATCHING & HOOK-UP GUIDE	22
TUBE GUIDE	28
PARTS LIST	29
SERVICE INFORMATION	30

IMPORTANT SAFETY INSTRUCTIONS

1. Before attempting to use this apparatus, read and follow these instructions for proper use.
2. Keep these instructions.
3. Heed all warnings.
4. Do not use this apparatus near water.
5. Clean only with a dry cloth, do not use any solvent such as benzene, naphtha or paint thinner on apparatus.
6. Do not block any ventilation openings. Install in accordance with manufacturer's instructions.
7. Do not install near any heat sources such as radiators, heat registers, stoves or other apparatus (including other amplifiers) that produce heat. Avoid placing the apparatus in direct sunlight.
8. Do not defeat the safety purpose of the polarized or grounding type plug. A polarized plug has two blades with one wider than the other. A grounding type plug has two blades and a third grounding prong (protective earth connection). The wide blade or third prong is provided for your safety. If the provided does not fit your outlet, consult an electrician for replacement of obsolete outlets.
9. Be sure that the amplifier's rated power supply voltage and frequency matches the voltage and frequency of your power source BEFORE connecting amplifier to the power source. The amplifier's rated power supply voltage and frequency are clearly indicated on the back panel near the power inlet, and the power cord's plug should match the power source in your region.
10. Protect the power cord from being walked on, pinched, or from excessive stress, particularly at the plug and attachment point of the apparatus.
11. Only use attachments and/or accessories specified by the manufacturer.
12. Refer all servicing to qualified service personnel. Servicing is required when the apparatus has been damaged in any way, such as the power plug or cord is damaged, liquid has been spilled or objects have fallen into the apparatus, the apparatus has been exposed to rain or moisture, does not operate normally or has been dropped.
13. To ensure proper ventilation, ensure that there is a minimum of 4" (10cm) of space at the rear of the apparatus. The ventilation should not be impeded by covering the ventilation openings with items such as newspapers, cloth, tapestries, curtains, etc. Do not impede ventilation by placing objects on top of the apparatus which extend past the rear edge of the cabinet.
14. No naked flame sources, such as lighted candles or oil lamps, shall be placed on the apparatus.
15. The apparatus shall not be exposed to dripping or splashing, and insure that no objects filled with liquids, such as vases or beverages, are placed on the apparatus.
16. The AC plug is the mains disconnect, the plug shall remain accessible after installation.
17. **WARNING:** To reduce the risk of fire or electric shock, do not expose this apparatus to rain or moisture.
18. **WARNING:** Do not defeat the safety grounding pin on the power cable, it is there for your safety.
19. **WARNING:** Do not open or perform any internal modifications on this apparatus.
20. **WARNING:** Do not attempt to repair the apparatus, or replace parts within it (except where this manual provides specific instructions directing you to do so). Refer all servicing to your retailer, the nearest authorized Mesa Boogie Service Center, or authorized Mesa Boogie distributor in your region.
21. **WARNING:** Always disconnect the apparatus from the power source before changing fuses, tubes or removing the chassis for service. Use only the same type and rating as specified on the back of the apparatus when replacing a fuse.
22. **WARNING:** Disconnect apparatus from the power source during a lightning storm or when unused for long periods of time.
23. **WARNING:** This apparatus is heavy. Insure that the apparatus remains stable after installation.
24. **WARNING:** In areas where children may be present, use additional precautions as needed to protect the children from the hazards presented by the unit. This includes risk of electric shock, burns and toppling over.
25. **CAUTION:** This apparatus contains hot components and surfaces. Avoid direct contact with heated tubes and other components. Insure that any factory installed guards remain installed.
26. **CAUTION:** Avoid contact with moving fan blades that may be present within the apparatus or cabinet.
27. **CAUTION:** Tube envelopes are glass and can present a hazard if broken. Always turn apparatus off, disconnect from the power source, and allow to cool before changing tubes.
28. **CAUTION:** To avoid damaging your speakers and other equipment, turn off the power of this and all connected equipment before making or changing connections. Power apparatus up with the volume levels set to minimum, and slowly increase to desired level.
29. **CAUTION:** Always insure that the proper speaker load is connected to the apparatus before operating the apparatus. Failure to do so may cause damage to the apparatus.
30. **CAUTION:** Do not use excessive force when handling cords, jacks, buttons, switches and controls. Never unplug the apparatus from the power source by pulling on the wire, use the plug body.
31. **CAUTION:** This apparatus, in combination with speakers and/or headphones, may be capable of producing sound levels that could cause permanent hearing loss. Do not operate for a long period of time at high levels, or at a level that is uncomfortable, without hearing protection. If you experience any hearing loss or ringing in the ears, you should immediately stop using the apparatus and consult an audiologist.

PRODUCT COMPLIANCE INFORMATION

Suppliers Declaration of Conformity for California Tweed 6V6 2:TWENTY Responsible Party

Gibson
209 10th Ave S Ste 205,
Nashville, TN 37203
United States
Telephone: + 1 615 933 6000



OVERVIEW

Congratulations on your choice of the California Tweed 6V6 2:TWENTY and welcome to the MESA/Boogie family. You have chosen wisely as this amplifier, though simple and straightforward in comparison to our multi-channel models, represents no less commitment to excellence, attention to detail and refinement in performance.

Fifty years in the making and looking forward to reinventing “Vintage” tone, we’re really pleased with this single channel, low power, “Old School” offering aimed at traditional sounds. Equipped with all the essential features you do need, none of the complexity you don’t and bona fide delicious 6V6 tone in three perfect wattage ranges, the California Tweed 2:TWENTY boasts a beyond classic sound and addictive feel that’s bound to keep you inspired, playing incessantly and growing musically.

In the twilight of the 1960s SF Bay Area amp repairman to the stars, Randall Smith, was inspired to start building his own amplifiers after coming to a deep appreciation for the ‘50s Tweed circuits Leo Fender created. He loved their organic sounding voice, powerful controls and the way they smoothly transitioned from clean to clip and back again. Standing on the shoulders of a giant, Smith’s first venture into building what is now called a boutique guitar amplifier saw the foundation built atop those wonderful, timeless sounding amplifiers. Five decades and myriad models later, we return to pay homage to that lineage, yet also bring forward with our 50 years of experience hand building high gain tube amps, an exciting new realm of Tweed-based performance and authentic 6V6 character.

While the traditional gain preamp on this model is relatively simple and straightforward providing the full compliment of gain, master, tone controls and presence, the power section is progressive in both design and operation and an evolutionary step forward in what many think of as Vintage-style amplification.

The tube compliment in standard form is tried and true, appearing on the classics, boutique builds and vintage Hi-Fi offerings, but what we’ve done with it is revolutionary. The update includes our Multi-Watt™ power section featuring Duo-Class™ along with our (originally patented) Dyna-Watt™ technology.

The incremental Multi-Watt™ switch encompasses a wide range of usable power levels and employs different operating classes and wiring configurations for tonal flexibility, venue-matching volume levels and character enhancing headroom choices. Multi-Watt™ is protected by 2 active patents and is definitely the state of the art in terms of taking old school tube tone to new and exciting performance levels.

Three power ratings featuring 2 operating classes and 3 wiring options are provided: 20 watts utilizing 2 x 6V6s operating in Class AB Pentode, 10 watts utilizing 2 x 6V6s operating in Class AB Triode and 1 watt harnessing 1 x 6V6 operating in Single Ended Class A Pentode. Throughout these ideal low wattage levels almost any musical style or venue can be accommodated.

With this advancement in power technology, tuning the headroom and riding the threshold of sweet, musical clip-ability is as simple as a quick flick of the wrist. It opens up the usefulness and flexibility compared to a single channel traditional amplifier and allows a much wider range of sounds based on power section saturation and volume levels.

FRONT VIEW: CALIFORNIA TWEED™ 6V6 2:TWENTY

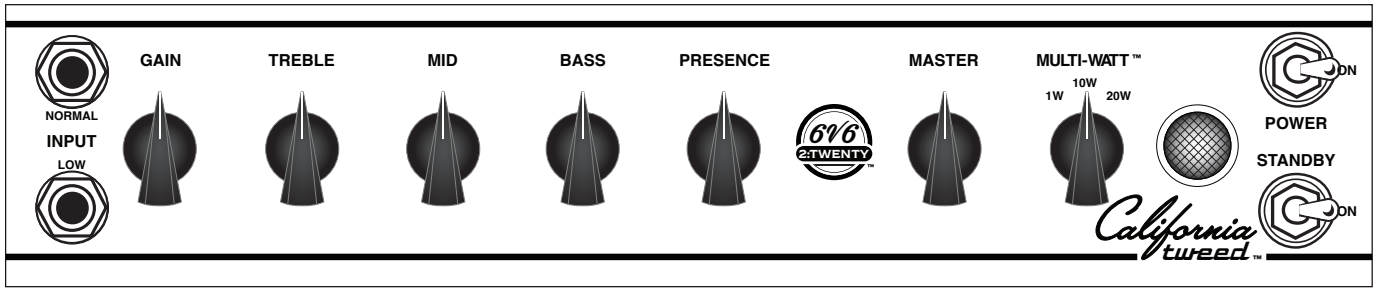

REAR VIEW: CALIFORNIA TWEED™ 6V6 2:TWENTY

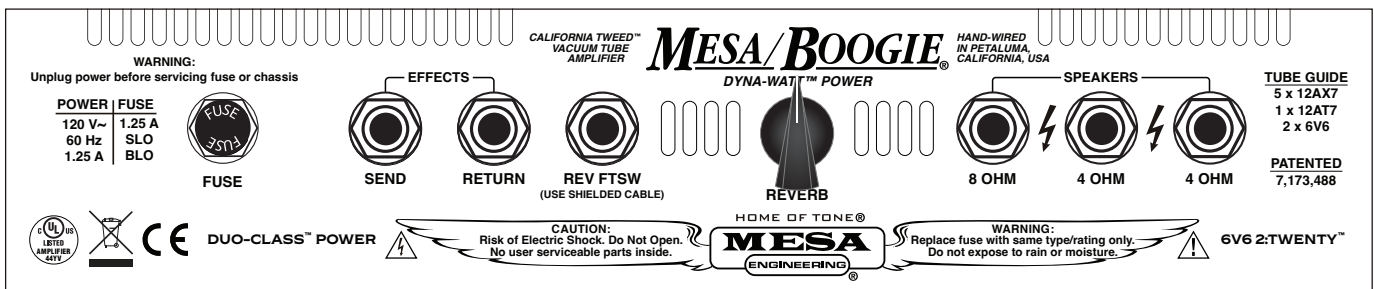

The reverb in this traditionally oriented model is different in sound and components in comparison to our other multi-channel models. It's voiced and optimized for the sounds fans of yesteryear's amplifiers are accustomed to and expect. The character is lush and deep with a brighter voicing and a longer but very usable "vintage" decay. It creates the ambience that authenticates the sounds dialed up in Tweed-based preamp and choice of unique power sections available on the Multi-Watt™ rotary. We feel it compliments the personality and character of the Cal Tweed perfectly and is arguably one of our best reverb circuits ever.

The rear panel of the California Tweed matches the front panel's simplicity and contains only those features that are consistent with its straightforward design, yet it accommodates the essential modern needs. Hence, the rear panel is very sparse compared to other MESA models and contains only SPEAKER outputs (one 8 and two 4 Ohm), the effects loop SEND and RETURN jacks and a reverb footswitch jack. In the spirit of the genre, less is more.

Cabinetry and its construction play a big role in the California Tweed's sound and character, along with a great traditional sounding Alnico speaker. Different and unique back panels and speaker baffles tune the combo and extension cabinets in this model and provide increased vintage-voiced resonance and a sweeter, less forward sound and feel. The Jensen Alnico Blackbird is perfectly voiced for traditional sounds, from Blues to Roots, Country to Gospel, R&B and everything in between with its organic midrange character and sweet, top end. This translates into a stylistically appropriate openness and dynamic response that is superbly expressive.

In combination all these choices and characteristics add up to a stylistically strong statement that stands ready to redefine as it brings new performance to an old game full of long-standing classics. We really hope you'll enjoy the enhancements and refinements to this class of amplifier as much as we enjoyed the process of bringing them to you and we hope they help bring you inspiration and your playing to new heights!

GETTING STARTED

1. After unpacking the amplifier, check to make sure all the tubes are firmly seated in their sockets as some may have loosened a bit during shipping.
2. Connect the A.C. Cord to a grounded (3 pin) A.C. outlet.
3. If you have purchased a head format, connect your speaker enclosure to the proper matching impedance SPEAKER OUTPUT on the rear panel, most typically to the 8 Ohm SPEAKER OUTPUT jack. An 8 Ohm load is preferable for your first experience with an amp this dynamic and explosive as you will hear the full power potential and best tonal balance. Combo amplifiers use an 8 Ohm internal speaker and it should already be connected to the proper impedance SPEAKER OUTPUT. If not, move the speaker cable to the 8 Ohm SPEAKER OUTPUT jack.
4. Flip the POWER Switch to the ON (right) position while leaving the STANDBY Switch in the STANDBY (left) position for at least 30 seconds. This allows the filaments to warm up in the tubes before being put to use. Following this cold-start procedure every time you power up will increase the toneful life of your tubes.
5. If you intend to connect processing devices to the EFFECTS LOOP, do so now. Look up EFFECTS LOOP in this manual for proper connection and operation. We recommend auditioning the California Tweed without processing for the first time, just to hear the pure sounds and get to know the amp by itself before adding processing. This also helps tell you if your processing might be robbing anything sonically from your new amplifier. If the loop is to be used, check the INPUT levels on your processor to make sure they are in the medium to lower range so you can increase the level slowly once you have lifted STANDBY on the California Tweed and play to view the SEND level coming from the amp.

NOTE: Pedal type processors don't usually have an input level indicator, some have clip lights, and on either of these types you'll need to trust your ears regarding levels

6. Follow the sample settings examples below and set the controls at these approximate settings for a tour through your new world of TONE. Remember these are just a glimpse at the vast possibilities and are meant to give you a taste of one possible way to set up your sound. Feel free to fine tune the sound as you go...you can't hurt a thing and you will be learning by feel...the best way.
7. Flip the STANDBY to the ON position and enjoy the ride!

INSTANT GRATIFICATION

In case you haven't yet played your new amplifier, below is just one example of the many ways to set up a sound. This example demonstrates a clean sound in the 20 watt power level.

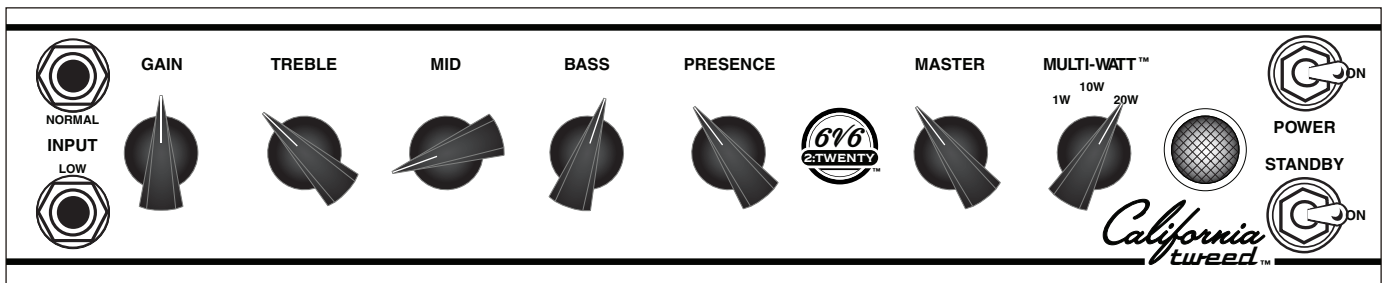

HELPFUL HINTS

NOTE: REDUNDANT INFORMATION: Throughout this operating guide you may encounter redundant information and sections that are repeated for your continued awareness and as reminders. This is done so you can reference

only the sections you are interested in, and yet still where necessary, get important points you should know about the California Tweed. We apologize if this gets annoying for the cover-to-cover reader, but even they may appreciate it sometime in the future when referencing this guide quickly for a specific topic.

- We suggest using the NORMAL input first to explore the amplifier, as it will provide the full range of sounds possible, including clip/overdrive sounds.
- For maximum headroom and clarity for clean sounds, try the LOW input and the 20 Watt setting on the Multi-Watt™ rotary. This INPUT may sound different, be slightly darker sounding and have less mid punch, but the preamp will tolerate more input signal before the onset of tube saturation/clipping, which may or may not be desirable depending on the stylistic application.
- Beware of high settings on the BASS control, especially when the GAIN is set high. Too much BASS will produce a flubby, indistinct attack and “slow” the response time. A basic rule regarding the BASS control might be this; As the GAIN goes up...the BASS should come down.
- The GAIN and TREBLE controls are the most powerful tone shaping controls and should be used with taste. They determine much about the attack characteristic and the overall personality of the sound. Many of the great sounds will find these two controls in their middle ranges.

NOTE: When possible, avoid setting the TREBLE high (above 2:30) when the GAIN is set high, as this can potentially bring about the tendency for a slightly microphonic tube to ring or squeal. Reducing TREBLE and even PRESENCE settings when the GAIN is set higher helps in avoiding this annoyance.

- Your amplifier will sound better, and also feel better to play, if you have at least one speaker cabinet touching the floor you are standing or sitting on while playing. The coupling effect and especially the transmission of bass frequencies, will cause the amp to sound fatter and the strings to feel more substantial and tangible in your hands when the amp (or cab) sits on the floor. Wood floors (like stages) are really great! Let’s face it... the guitar can be one of those instruments that rarely feels the same way two days in a row, night to night, from room to room... and we can use all the help we can get. This simple practice usually helps... with the only exception being a stage filled with many live mics. Sometimes then you are forced to lift the amp to avoid the coupling effect creating resonances that will cloud up a mix or cause things to “runaway” in the low end in the house sound or stage monitor system.
- Use the STANDBY switch every time you take a break and/or power-up (from cold or hot) during set breaks, cable hook-ups and anytime you are not playing for a few minutes. Doing so will increase the toneful life of your tubes.
- Circuits emanating from this “other side” of the MESA Line (as in non-MARK amplifiers) like your California Tweed, tend to favor TREBLE and PRESENCE control settings on the lower side for sounds that are balanced and/or in the warmer domain. Depending on guitar woods, pickups and technique, don’t be surprised if you find great sounds below 12:00 on the TREBLE and PRESENCE.
- In the California Tweed, different and unique top end frequencies are found in the TREBLE, MID and PRESENCE controls. We suggest becoming familiar with what each of these powerful controls bring out or bury in the mix and learn to “swap the top” as you see fit for different styles, characters, responses and attack center-points. Spending a little time early on with these three powerful tone (and “dynamic”) controls will allow you to dial up sounds quickly and easily and enhance the enjoyment of your amplifier.
- While the California Tweed’s output section is not overly sensitive to impedance matching, its sound is affected by it. We suggest auditioning the 4 Ohm speaker output on the two lowest, 10 and 1 Watt, power selections as the 4 Ohm output produces different characteristics. The sound may be brighter and punchier in the 8 Ohm jack, but regardless, leaving it in the 4 Ohm output will not harm the amplifier and for some sounds or players, the mismatch may be preferable.

FRONT PANEL

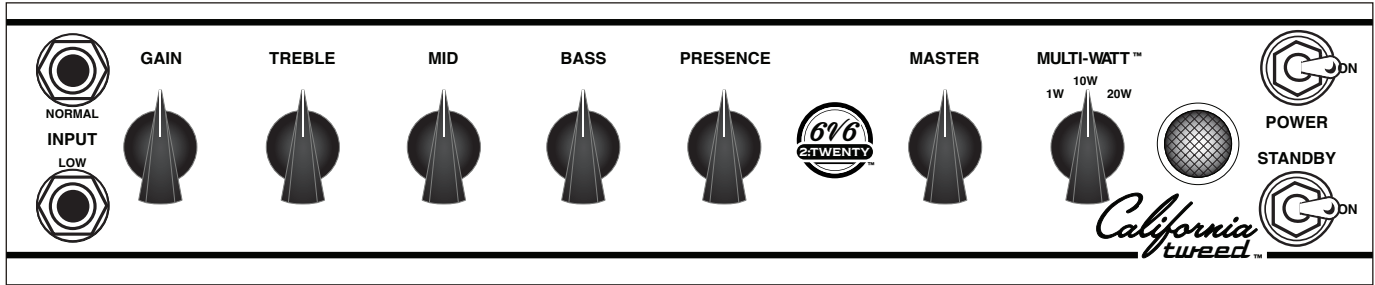

INPUTS

Two INPUTS are provided on the Cali Tweed to allow for different gain levels, pickup output levels and tone.

NORMAL is the “full strength” input and allows the full signal of your instrument to hit the first stage of the preamp with all your guitar has to say about output. This input allows more touch sensitive transitioning between clean and saturated sounds when the GAIN control is set above approximately 12:00, depending on your pickup’s output strength. The higher the setting of the GAIN control, the more easily you will be able to push the preamp into clip, and even power section (depending on wattage selected on the rotary POWER SELECT) into saturation/overdrive.

The NORMAL input is also the brighter input and allows the maximum harmonic content from your instrument to pass through the preamp. This will ensure the tone controls react with their full power and that gain levels are allowed to reach their maximum. Most of the critical “Toning” during the development of the amplifier was done using the NORMAL input, so as to ensure all gain regions and frontiers were explored and refined to their absolute maximum potential. We suggest using the NORMAL input first and exploring the amplifier, as it will provide the unadulterated full range of sounds possible with any given guitar.

The LOW input should be explored for maximum headroom at the input of the preamp, and/or for the absolute cleanest (not necessarily brightest, which can often be confused for cleanest) response and character. For the loudest, greatest headroom clean sounds use the 20-watt setting on the Multi-Watt™ rotary.

The LOW input is “padded” so that a reduced signal is presented to the first preamp tube stage. This padding also reduces the midrange punch and brightness, so you will have to determine what is most important to you, headroom or “cut”, and choose inputs with that in mind.

More cut would actually be found with the NORMAL input, as though it may be less pristine in terms of the onset of clip, it’s inherent punch and more active tone control string response due to the higher signal strength, may actually sound cleaner or feel better in an ensemble. Experiment with both inputs to learn which one works best for your application.

Just be aware that brightness (as in EQ) is often confused with headroom, clarity and even power. Brighter sounds feel faster, cut through a dense mix more effectively, and in general, can appear as having increased headroom. That’s partly because high frequencies reach your ear faster than low frequencies do and therefore the feedback to your hands and ears is more immediate than with darker, warmer sounds. This can be a bit deceiving at times though, so use your sense of feel and your ears to make the determination about which input is best for a given application.

The LOW input and its inherent top end roll off can be nice for Jazz playing or single note solo work where increased cleanliness and a warmer character is desired. It may take a bit to get accustomed to the less immediate, less forward feel as compared to the NORMAL input, but there are some nice and unique sounds available using

LOW when you explore it for the right applications. Just remember that it will be all but impossible to achieve much clipping, or even subtle breakup, in LOW as the instrument's signal strength just won't be there to push the preamp stages into much saturation.

GAIN

This is by far the most powerful control in the preamp and its setting determines the style and personality of the sound. It meters the gain and it sets input stage headroom, which determines whether the sound will be clean or begin transitioning into saturation/clip. It also acts as a subtle tone control as the early tube stage's gain is increased and decreased and imparts its own "color" on the sound.

There are three regions of the GAIN control; a low gain zone between 9:00–11:30, a warmer, more saturated zone from 11:30–2:00 and a higher gain zone from 2:30–5:00. Each of these zones can be used for many different applications and all can be used for both chording and single note solo work. As the GAIN control is swept throughout its range it imparts different textures and tonal characteristics.

Generally speaking, the lower end of the control (9:00–11:30) produces a brighter, more open character that has more dynamic content available. This region is great for clean chording where the maximum headroom is available, the top end harmonics are bubbly and the attack is fast and immediate feeling. There is an abundance of dynamic range as the signal has not yet been compressed by much saturation. Just keep in mind the lower you set it, the more top end will be introduced and also, the higher you will need to set the MASTER control for a given playing loudness.

The middle region of the GAIN control (11:00–2:00) is where the most balanced sounds live and you will find this region delivers warm, full sound, detailed attack and good dynamics. This range delivers great chording response, sounds richer and has more body with the cleanest sounds falling off fairly rapidly as the GAIN passes 12:30. Depending on pickup style and strength you will have to watch for clipping as you are nearing the crossover or threshold point, gain-wise, between clean and saturation. Some of the most expressive and sweetest sounds are to be found in this zone where things start smearing nicely as they transition more and more toward tube overdrive. It is probably fair to say this zone contains what most players using traditional gain amps are seeking; a perfect transition between clean and clip. That's what the California Tweed is all about and this 20 watt model even more so due to its perfectly clip-able power range.

The highest region of the GAIN control (2:00–5:00) is all about saturation. Up here the signal gets much bigger in the low end and the top end begins to smear and recede to create a rounder, more compressed sound. Dynamics become a little slower with naturally compressed peaks and a more sponge-y, forgiving feel is produced. The highest region of the GAIN control produces some great pushed sounds as the input stage gives it up and starts to saturate. This range of the GAIN control turns this traditional "clean circuit" into a viable and very expressive vintage-inspired single note soloing sound. With an already thicker base of gain, the upper region also accommodates diode and tube based overdrive pedals nicely as they increase saturation and/or signal strength at the INPUT.

You may be surprised how aggressive the upper region of the GAIN control can be on this "traditional" amp upon finally unveiling its true potential for Vintage-inspired crunch rhythm and even Rock soloing. There is ample gain up here to rip into most any style you wish, save for perhaps Modern Metal, pumping out surprisingly thick harmonic layers for chording and/or very expressive and nuanced overdrive for single notes.

At the highest GAIN settings you may notice the tone controls have a slightly diminished effect on the sound. This is because the notes are becoming quite saturated and their character has been determined by the circuit's overall voicing as it reacts to this level of gain.

NOTE: TONE CONTROLS: In the Cali Tweed, different and unique top end frequencies are found in the TREBLE, MID and PRESENCE controls. We suggest becoming familiar with what each of these powerful controls bring

out or bury in the mix in terms of top end and learn to “swap the top” as you see fit for different styles, characters, responses and attack center-points. Spending a little time early on with these three powerful tone and “dynamic” controls will allow you to dial up sounds quickly and easily and enhance your enjoyment of your amplifier.

TREBLE

While the GAIN is the most powerful control in the preamp, the TREBLE comes in a close second. The TREBLE is largely responsible for shaping the character of the sound and its response in the tonal realm. It can overpower the rest of the tone controls due to its “cut and slice” component and therefore its setting is crucial to a rich and balanced sound. Setting the TREBLE with care and taste in mind is critical for achieving an overall blend and assuring the tone control string works harmoniously.

The middle region of the TREBLE delivers the best balance and creates sounds that are plenty bright enough, yet still rich and warm. May we suggest you start with the TREBLE at 11:00 and adjust up or down slightly until the desired blend is achieved. That said, circuits emanating from this “other side” of the MESA Line that share Tweed-based DNA reveal low TREBLE and PRESENCE control settings that are very useful and pleasing. Depending on guitar woods, pickups and technique, don’t be surprised to find great sounds below 11:00, and even very low, on the TREBLE and PRESENCE. The MID’s broad Q carries a substantial amount of top end and even though lower and different, it will at times provide all the cut you’ll need for some things.

For higher gain sounds, especially for single note soloing, experiment with the TREBLE and PRESENCE around 10:00–10:30 and the MID around 9:00–9:30 for a rich creamy response that feels great on the strings and sounds soulful and pleasing. Adjust up or down to taste, but you will likely find the most vocal and round attack characteristics down in this range, especially for longer “Fender Scale” instruments. Shorter scale guitars like Gibsons and/or darker sounding woods like mahogany may require a little higher settings on these three controls, or a deviation in ratio between them, for the best balance and harmonic content.

MID

The MID control brings in and out a broad band of midrange frequencies and along with these ride a fair amount “low treble” range frequencies. These high frequencies are lower than those residing within the TREBLE’s domain, but they are important for the punch and cut in a mix.

For rhythm playing, but also globally, a lower MID setting (7:30–10:00) scoops some of this midrange attack and makes the bottom end breathe more, while at the same time, letting the higher harmonics define the top end with increased sparkle, chime and openness. This range will also make things more resilient and create an easier to play, more elastic feel on the strings. Single coil guitars work very well here for the slinky, rubber-band attack and bouncy bass character associated with Blues, R&B and Country or most any styles based on bright, bubbly clean response.

The middle region of the MID control (10:00–1:00) is where the punch and attack begin to come on with more urgency. This is where mahogany guitars really like to see the MID set for cut and definition. Here the top end begins to show itself in the mix of the MID controls’ spectrum and chording sounds start to punch with a more forward character.

From there on up (1:00–5:30) the MID introduces an aggressive range of sounds that are still full, but also quite forward as the dominant frequencies become those present under control of the MID. In this range you will likely have to increase the BASS to add back in some richness and warmth that can get overshadowed when the MID control is set high. If you like the attack and urgency found in this range of the MID, all the other controls (except maybe the MASTER, which you may have to back down as the sound gets more forward) may have to be set higher to keep up with the MID-dominant curve. This is fine, although there will reach a point of diminishing return as the headroom in the preamp gets eaten up by this tonal “arms race” of frequencies and you begin to clip the preamp with the increased signal from setting the tone control string higher.

For gained-up sounds at the top of the GAIN control a similar story unfolds as the MID is increased. Lower settings (7:30–10:30) will produce wider sounding, more elastic feeling chording sounds and the single notes will have a creamier, smoother character. High harmonics created by the gain and controlled largely with the TREBLE, will put a patina of three-dimensional, harmonic-enriched haze on things and will allow them to “smear” nicely.

As the MID is increased past the 10:00 range, cut and bite begins to creep in along with a more chesty midrange punch. This is where, depending on guitars and pickups, you may approach some classic “almost-70s “Crunch” chording sounds. The MID kick found here is an integral part of the impact and tight-tracking accuracy of iconic medium-gain sounds that have been Rock staples over the last five decades. The preamp is traditional in nature and therefore, not able to go all the way to what we think of today as “Crunch”, but reducing the power to the lower wattage settings (10 watt and 1 watt) can expand the available gain range, albeit in the power section, and therefore of a different character.

Passing 1:00 on the MID unleashes the brash attitude and top end also joins the party. Here is where you look for the most forward and aggressive attack over a wider range than that found in the TREBLE control. The feel on the strings will become less forgiving and your playing will be put under a microscope in the time domain, but if it’s cut and punch you need, this is a great place to find it. This region is great for pushing Rock rhythm sounds to the forefront of a mix. Single note solo sounds in this range on the MID will be fast and accurate and certainly notes will have a definite point of origin in the bar line.

One suggestion... the MID control contains frequencies that can be a little tough on the ears at times. You might be surprised how much impact – and along with it possibly even unpleasantness – can be dialed in with higher settings of the MID. The TREBLE and PRESENCE as well. Unless you are out to hurt people, which is never a good idea, you may find the middle to lower range of the MID gives you plenty of attack and definition, yet still sounds balanced and warm and allows others to enjoy your playing without wincing at every note.

BASS

The BASS control blends in a fairly wide region of rich bottom end to round out the sound. Being an amp that needs to have luscious clean sounds as well as traditional Tweed clipping potential, we have taken liberties with tradition to expand its usefulness and enrich its character for the bottom half of the GAIN control. This was one of our biggest challenges in the development of the California Tweed and once dialed in, became one of our proudest achievements: to have response similar to Blackface architecture at the low end of the GAIN control, yet more Tweed-like response once the GAIN is increased past 12:00 noon. Much of this trick is achieved through diligent work with the BASS region of the circuit and associated tone control string, the rest is dependent on overall gain structure and its perfection. The end result is a traditional-voiced amp that does double duty shockingly well and is something we have long dreamed of, but never before experienced in real classics or “Vintage-styled” amps.

A great sound will always be dependent on a good ratio between the GAIN and BASS controls. Depending on the setting of the GAIN control and guitars employed, generally speaking cleaner/less saturated sounds (lower GAIN settings) can handle higher BASS settings. More saturated/overdriven sounds (higher GAIN Settings) will require lower BASS settings for the best balance and an accurate, defined attack. Obviously there will be times these suggestions won’t be relevant and also, whatever you do to the bottom end affects the top end and vice versa, but these are good general guidelines for many great sounds.

You will have to experiment with your own instruments, however the scenarios below provide guideline examples. If you at least begin with this simple common sense approach: as GAIN goes up - BASS should come down, you’ll find great sounds easily and quickly.

Examples:

GAIN at 12:00 – BASS at 1:00	GAIN at 1:00 – BASS at 12:00	GAIN at 2:00 – BASS at 11:00
------------------------------	------------------------------	------------------------------

Again, this is just to give you an example of the concept. The offset differences might be greater or less depending on guitar, speaker cabinet, room, live mics on stage, outdoors vs. indoors, etc., but the concept should serve you well.

And finally, the nice thing about the BASS control is that it's the least affected by other tone controls and really the GAIN is the only control you will need to consider with it as far as avoiding less than optimum sounds. Unlike the TREBLE, MID and PRESENCE, which share the top end duties across a wide spectrum from high midrange all the way to the harmonic region above what the TREBLE and PRESENCE affect, the BASS is a one stop shop in terms of dialing in rich low end.

PRESENCE

This control adjusts high frequencies above those of the TREBLE, is located farther downstream in the signal path than the standard tone controls, and adjusts top end response in the power section. You can think of the PRESENCE as a control that allows you to either clamp down the highs in the power amp - compressing and darkening the sound - or open it up and let the full spectrum of upper harmonics come chiming through. It also has a great deal to do with how dynamic the signal is and again, how a sound will cut through the mix in an ensemble environment.

At low settings (7:30–10:30) the sound will be warm and round with a more compressed feel and dynamic attack, especially in the upper frequencies that add urgency, will be softened and “limited”. As the PRESENCE is increased (11:00–2:30), the top end starts to become more dominant and that compression gives way to “cut” and dynamic peaks jump out with speed and accuracy.

At the top end of the control (2:30–5:30), an aggressive blend of upper harmonics dominate the sound and this region can be somewhat dangerous if it's not applied in small measures. Higher notes will slice and dice even the bravest set of ears and we suggest using this region mostly in the studio for recording where the sound can be isolated and applied in context. Even then, you may find its most appropriate applications on parts that feature the lower strings. This highest region – especially when coupled with the inherent curve of many of the microphones typically used in P.A. (sound reinforcement) applications, can be punishing in the wrong hands, so be cautious and courteous to your band mates and audience and dial the PRESENCE with care.

Clean sounds often benefit from a bit higher PRESENCE settings (10:30–12:30) more than sounds that have overdrive involved in their makeup. Once saturation begins, the frequencies carried in the PRESENCE control can make things edgy or brittle... even buzzy, if you aren't careful. Similarly, overdriven chording sounds can usually tolerate higher PRESENCE settings (10:30–12:30) better than single note playing, which usually wants to roam the zone below 11:00 to stay round, focused and vocal.

NOTE: As mentioned earlier, the entire top end spectrum is shared among the TREBLE, MID and PRESENCE, each having its own region, power (effectiveness) and character in the overall signature of the top end. When dialing in your sounds make sure to use all three of these controls to balance the different frequencies and achieve the best blend and feature the most pleasing top end.

MASTER

This control determines the overall output level and is located at the very end of the preamp. By using it in combination with the GAIN control, any amount of preamp signal strength – gain – (within the California Tweed's traditionally-oriented gain parameters) can be achieved at any playing volume. Once you have dedicated the GAIN control to the desired type of sound, clean or overdriven, you can then balance the volume level using the MASTER control.

In addition, the MASTER, along with the setting of the GAIN control way upstream, functions as an EFFECTS SEND level control for the EFFECTS LOOP. The levels have been optimized at the SEND to accommodate the widest range of usable sounds, so you will never likely know all the trouble we go to in making sure not only do

these elements work seamlessly to protect the integrity of your tone WITHOUT using the loop, but also so you can rest assured your processors will interface nicely without compromising it. However, please remember that EVERYTHING in the signal path is a “tone element”, so keep that in mind when choosing processors to place right in the middle of your amplifier. Try to use processors of good quality that utilize good input and output stage designs, as well as microprocessors/engines and/or analog circuitry.

Some (purists) like running the MASTER all the way up and raising the GAIN to the desired sound and volume. The thinking here is that this scenario achieves the purest sound and most immediate attack. In theory this resembles removing the MASTER control altogether from the signal path, and in one way it does. However, most all the “vintage non-master” amplifiers this approach hopes to emulate have discrete resistors in that location in the circuit anyway to adjust or “tune” the output of the preamp to the power section input sensitivity. So really, there is no real difference because potentiometers are simply variable resistors. It’s just like having your choice of fixed resistors you can sweep through that allow adjustment of the input sensitivity of the power section.

The MASTER is nothing more (intrusive in that regard) than a variable “resistor ladder” that offers a nearly infinite range of settings possibilities and makes the amplifier many times more versatile without sonic penalty. If you prescribe to the old school approach, by all means use it... it won’t hurt the amplifier. However, you will be limiting the potential sounds you can achieve by removing the great sounding combinations of GAIN and MASTER settings. You may also be challenged to achieve optimum levels at the input of any processing you might try to use in the effects loop, for as mentioned earlier, the MASTER also determines the SEND level signal strength.

REVERB

The California Tweed 2:TWENTY incorporates an analog all-tube spring reverb circuit that produces lush, ambient reverb effects, from subtle to fully-drenched “Surf” levels, that enhance its vintage-oriented character. This control is the easiest to operate on the entire amp because what you hear is exactly what you get and, other than the physical interaction of volume and whatever harmonic resonances that might create, it is largely autonomous in nature and shares no duties.

That said, much like the BASS, the more extreme the setting of the GAIN control is, the more sensibly the REVERB may want to be applied, unless it truly is Surf music you’re playing. Luckily, this seems to follow the stylistic boundaries to a certain extent, in that most players who use gained-up sounds tend to rely more on delay than reverb as their main form of adding a spatial quality to their sound. To be fair though, that notion may not apply so much to overdriven rhythm playing in say a Blues or Roots style, especially when it’s time to be dramatic.

In the traditional world of clipped clean, where clean amps cranked-up produces the desired flavor, the sound of reverb tanks and their springs being overdriven, along with the analog circuitry feeding them, is an integral part of the authenticity and vibe. Feel free to utilize the REVERB set high for this application... crank the preamp’s GAIN control and set the REVERB to your desired saturation level.

Just remember that reverb is essentially an electro-mechanical moving part at its core and therefor it’s affected by nearby and/or internal physical elements such as vibration, both in the amp from high volumes, and externally. ...And by certain frequencies as well. Everything that vibrates can potentially resonate with other things vibrating. The clear example of this is REVERB set at very high levels “feeding back” or running away on certain notes when a combo amp is played at very high volume levels and the internal speaker is shaking the whole cabinet.

We go to great lengths to ensure your amplifier is as impervious to these anomalies as possible during the design, build and play-testing processes, but the real world of long road trips in trucks or airline flights, loud gigs with excited drummers and bassists can all subject the reverb’s mechanical components to rigors that tax it’s design and components. Some of these can be avoided or minimized by careful transport, wise setup, sensible volume levels and vibrational isolation within your playing environment.

NOTE: Should you experience any vibrational and/or mechanical issues with the REVERB, try reducing the REVERB

control, or even some of the other controls, to see if perhaps a slight adjustment of settings will eliminate or reduce the feedback, resonance or anomaly.

MULTI-WATT™

As mentioned in the overview of this manual, your California Tweed presents the next evolutionary step in traditional amp all-tube power sections. This dream-realized flexibility in power ratings all in the same amplifier is both revolutionary and extremely useful. It features the iconic and gig-able 20-watt power rating and two lower power options across 2 Operating Classes, Class AB Pentode and AB Triode along with Single Ended Class A wired Pentode for a total of 3 Wiring Options (listed below).

These lower to lowest wattage levels can enhance many musical styles and cover small to midsize venues. The best part is you'll have room to move up or down the power scale seamlessly on the fly in the heat of a performance with the handy front panel Multi-Watt™ rotary control.

With this patented power technology, tuning the headroom and riding the threshold of sweet, musical clip-ability is as simple as a flick of the wrist. It greatly enhances the usefulness and flexibility of a single channel traditional style amplifier and allows a much wider range of sounds based on power section performance, and where appropriate, power tube saturation.

Three power ratings featuring 2 operating classes and 3 wiring options are provided:

- **20 watts running 2 x 6V6s operating in Class AB Pentode**
- **10 watts running 2 x 6V6s operating in Class AB Triode**
- **1 Watt running 1 x 6V6 operating in Single Ended Class A Pentode**

Among these different wattage selections and “voicings” (as each has its own character, clip threshold and EQ curve) you will find many different tones and responses that allow you to roam much farther than any traditional amp before. Spend time exploring each of the wattage ratings to learn its character and best application...you'll quickly understand that whether clean or overdriven, the California Tweed is also California Gold when it comes to iconic guitar sounds in the 6V6 realm.

POWER

This switch controls the AC power mains in your amplifier. Always make sure the (supplied) IEC power cable is connected to a grounded outlet delivering the proper AC voltage, 117v USA. Never alter the power cable as doing so may cause damage to the amplifier, increase the risk of electric shock for you, and will void your warranty. Always follow the cold start procedure below and allow the tubes to warm up before turning the STANDBY on (switch right) as this will help the tubes and all other components in your amplifier to provide years of reliable service.

STANDBY

This large toggle controls the high voltage to the power tubes and from cold start, helps minimize the inrush of current and reduces the “shock” on them during power up, which ultimately helps increase their useful life. Just like a light bulb, much of the wear on tubes happens at the instant of power up. Minimizing this shock and allowing them to warm up more slowly ensures they will give you the longest life possible.

Before POWER is switched on, make sure the amp is in STANDBY (switch left). Wait at least 30 seconds and then flip the STANDBY switch to the ON position (switch right). STANDBY is also very useful as a mute for short interruptions like changing instruments or patching cables, as well as longer intervals such as set breaks or other extended periods. While you can leave the amplifier in STANDBY mode for hours with no harm, it is probably wise to power down completely with the POWER switch if you know you won't be playing for an hour or two. ...Why waste the electricity? Just remember to follow the cold start procedure mentioned below when you power back up, even if the amp is still “warm”. The filaments in the tubes cool much more quickly than

even the glass they are encased in, and they return to their “cold” state even after a short time with the power off. This procedure, when followed religiously, will help prevent tube problems and extend their useful life.

COLD START PROCEDURE

(Use every time amplifier has been switched off for more than 3 minutes)

1. **Switch to STANDBY (STANDBY switch left)**
2. **Turn POWER to ON (POWER switch right).**
3. **Wait AT LEAST 30 Seconds, preferably longer, for tubes to warm up.**
4. **Flip STANDBY to ON (STANDBY switch right)**

NOTE: This cold start procedure is an important part of ensuring maximum tube life and reliability. Like a light bulb, the most wear occurs during the instant voltage is first applied. Like a light bulb, if a dimmer is used to reduce the voltage for the first few seconds or so of use, increased longevity is the result. The STANDBY is the amp’s equivalent to a dimmer and using it in the above described method will ensure the longest life and best performance from a set of tubes (especially output tubes).

That’s it for the front panel features and controls, now let’s jump to the rear panel.

REAR PANEL

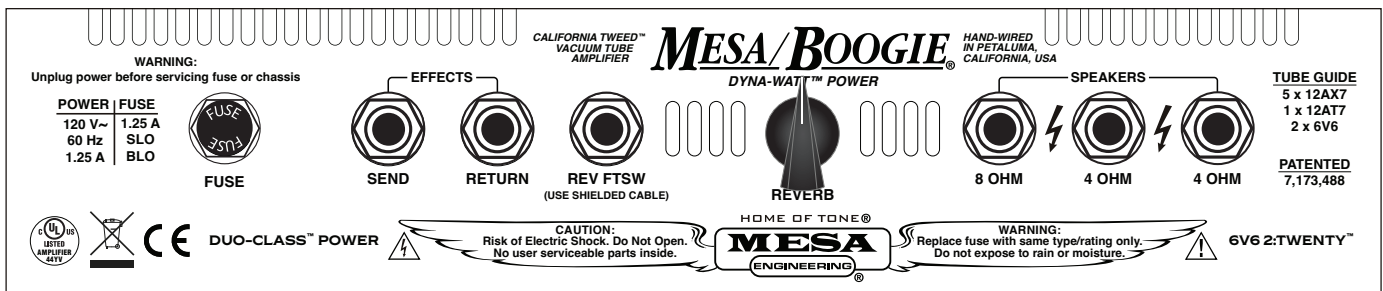

POWER OUTLET/AC MAINS SOCKET: (Removable IEC TYPE)

Underneath rear panel: This is the AC MAINS power cord socket. The standardized removable power cable supplied with your amp can only be plugged in one way. Always connect the male end to a grounded (3-Hole) wall socket with the proper voltage present (117 Volts on U.S.A. Models). To avoid the risk of shock, never alter the power cable in any way. Altering the power cable will void your warranty and put you at risk of shock while leaving your amplifier open to the possibility of damage.

FUSE

This is the A.C.’s (Alternating Current) main fuse and provides protection from outside A.C. fluctuations as well as power tube failure damage. Should the FUSE blow, replace it with the same rating in a Slo-Blo type package. The Domestic 117V version requires a 1.25 Amp Slo-Blo fuse. A power tube short or failure is often the cause of a blown fuse. Follow the cold start procedure mentioned in the STANDBY switch section and watch the power tubes as you flip the STANDBY to the ON position. If a power tube is going bad or is arcing, you will see it glowing red hot in the center! Flip the STANDBY switch down immediately and replace the faulty power tube and the FUSE if necessary.

EFFECTS LOOP (SERIES)

These two ¼” jacks provide the interfacing patch points for your “rear end” processing needs ...things other than drive pedals, wah, compressors, fuzz, etc., that usually work better on the amplifier’s INPUT.

The effects loop is basically a circuit bridge from the end of the preamp to the driver stage in the power section,

with the SEND interrupting the signal at the preamp's end and the RETURN feeding the signal back in right before the power section, just before the driver tube.

Using this patch point usually ensures the best sonic performance as well as signal to noise ratio with your outboard processors not used between the instrument and the amplifier's "front end" INPUT. That said, it is important to point out that this is a critical junction in the California Tweed's circuit path and whatever is inserted here can have an effect on the overall performance of the amplifier.

The effects loop is a series loop, meaning that the entire signal goes through it, unlike a parallel loop where a portion of the pre-processed "dry" signal is taken around the loop and mixed back in with the processed "wet" signal. Because the effects loop is a series configuration and the whole signal passes through it, the quality and performance of the devices used in the loop is critical to achieving the best sound and feel from your amplifier.

A word on processors: We recommend auditioning any prospective processor with your amplifier BEFORE buying it to ensure it delivers a good match in performance. One clue to quality is price. Like in any segment of the marketplace, you get what you pay for most times and there can be a wide range of quality in regards to both build and sonic performance. While technology has raced ahead at a frightening pace and features are at an all-time pinnacle, it is sound and feel you've likely chosen your pure analog all-tube amplifier for, so we recommend a similar degree of discretion when it comes to choosing your processing devices. Ultimately, what you insert in the middle of your amplifier's signal path can have a lot to do with how it performs.

To connect your processors:

1. **Connect the SEND to your processor's INPUT**
2. **Connect the RETURN to your processor's OUTPUT.**

Set your amplifier to the desired gain, tone and master settings and check the processor's input and output levels making sure there is ample headroom on the input and return gain on the output. A good way to tell if you have optimal settings and check the quality of your processors and cabling is to remove the cables from the SEND and RETURN jacks on the amplifier. Hopefully the signal will remain relatively unchanged in terms of volume and integrity. If the level drops when you unplug the cables, less gain is needed at one or both places in your processor signal chain. If the signal increases then you will need to increase the processor's input and/or output gain to achieve some "make-up gain". If the processor is of good quality it should provide good performance and little loss or gain without extreme settings on the device's input and/or output.

Effects Loop Cabling: It is always best to use the shortest lengths possible, unless you intend to run very long lengths and use a buffer. Though your effects loop IS buffered, there can be some minimal sonic penalty when using longer cable lengths.

Always use shielded, high quality cables of the shortest length possible to connect your processors to the effects loop.

If you can't achieve an almost seamless balance between the processor plugged in and it removed from the loop with the processors input and output level controls, perhaps its quality — or at least that of its input and output circuitry — is in question. Again, most times you get what you pay for.

REV FTSW (REVERB FOOTSWITCH JACK)

This jack allows remote on and off control of the reverb circuit so that you can bypass the effect remotely for parts that are more suited to dry a sound. You can use an optional MESA reverb footswitch or, connect any standard latching type (non-momentary) ON/OFF foot switch to the REV FTSW jack with a SHIELDED cable and toggle the reverb on and off. The REVERB control must be turned up to a level where audible reverb effect is part of the mix, say 9:00 or above, in order to use the feature effectively.

SPEAKER OUTPUTS

These are the speaker outputs for your cabinetry or in the case of a combo, the internal speaker. As mentioned earlier, we prefer 8 Ohm speakers/loads whenever possible for many reasons from sonic character to adaptability with other speaker cabinets, and feel your amplifier sounds its best with that impedance loading it. The 8 Ohm speaker in the 1x12 and 1x10 combo should be connected to the 8 Ohm SPEAKER OUTPUT.

In the 10 and 1 watt positions on the Multi-Watt™ rotary, for a more “proper” impedance match and a different tone (slightly brighter), you may also connect the single 8 Ohm internal speaker (or extension cabinet if you have the head version) to the 4 Ohm SPEAKER OUTPUT. This is not essential and it will NOT hurt the amplifier to leave the single 8 Ohm speaker (or any 8 Ohm speaker load) in the 8 Ohm jack in the two lowest wattage settings. In fact, you may prefer the sound of this (slight) mismatch produces, as it is a little warmer and smoother sounding. While a mismatch produces slightly less power, (8 Ohm load on the 4 Ohm speaker output(s)), it does provide an optional response curve and a sound worth auditioning.

When using the combo by itself or the head through a standard MESA 8 Ohm 1x12, 2x12 or 4x12 extension cabinet, use the 8 Ohm jack. Most MESA 2x12 cabinets are also wired to 8 Ohms and they can be used in this output as well.

Adding a second 8 Ohm speaker or cabinet we advise connecting them each to a 4 Ohm output. Current and recent MESA cabinetry also provides a parallel jack that allows daisy-chaining and connecting the first 8 Ohm cabinet to the 4 Ohm jack this configuration mimics connecting each 8 Ohm speaker to a separate 4 Ohm output. Regardless of which way you connect this setup, it will provide a better impedance match and ensure the full power and headroom is available.

A single 4 Ohm cabinet should be used with the 4 Ohm output.

A 16 Ohm 4x12 cabinet or 2x12 cabinet should be used in the 8 Ohm output and will result in a slight reduction in maximum power, though it will likely be imperceptible with the additional coverage four, or even two speakers, provides.

Two 16 Ohm cabinets connected to the 8 Ohm output (with a “Y” cord/box) will produce a better impedance match and will offer the full power and headroom.

NOTE: IMPORTANT! We do not recommend using two 4 Ohm cabinets as this will present a 2 Ohm load to the output transformer and put undue strain on it as it was not designed for this application.

These common cabinet connection scenarios will cover most of the widely used setups you will run into. There are likely others less common that we have not identified here, and some may also be safe and unique sounding. Feel free to call us if you are concerned as it is always better to be safe when it comes to ensuring proper loading of an expensive tube amplifier. Our Product Specialists will be happy to guide you and/or get you the proper information regarding impedance matching.

That’s it for the features, controls and interfacing of the California Tweed. We hope this manual and operating guide helps you get the very best performance from your new amplifier. Here’s wishing you many years of amazing tone and inspiration from the California Tweed. We feel confident it will reward you many times over for your initial investment and help you take your playing and musical endeavors to exciting new heights.

From all of us here at MESA/Boogie, Cheers and Enjoy!

FACTORY SAMPLE SETTINGS

SWEET VINTAGE CLEAN

Factory sample settings for Sweet Vintage Clean mode. The controls are: Input (Normal), Gain (Low), Treble (Mid), Mid (Mid), Bass (Mid), Presence (Mid), 6V6 2-TWENTY (Mid), Master (Mid), Multi-Watt (10W), Power (On), Standby (On). The California Tweed logo is visible in the bottom right.

MAX HEADROOM CLEAN

Factory sample settings for Max Headroom Clean mode. The controls are: Input (Normal), Gain (High), Treble (High), Mid (High), Bass (High), Presence (High), 6V6 2-TWENTY (High), Master (High), Multi-Watt (10W), Power (On), Standby (On). The California Tweed logo is visible in the bottom right.

SWEET TRANSITIONS

Factory sample settings for Sweet Transitions mode. The controls are: Input (Normal), Gain (Mid), Treble (Mid), Mid (Mid), Bass (Mid), Presence (Mid), 6V6 2-TWENTY (Mid), Master (Mid), Multi-Watt (10W), Power (On), Standby (On). The California Tweed logo is visible in the bottom right.

PUTTING SOLO

Factory sample settings for Putting Solo mode. The controls are: Input (Normal), Gain (High), Treble (High), Mid (High), Bass (High), Presence (High), 6V6 2-TWENTY (High), Master (High), Multi-Watt (10W), Power (On), Standby (On). The California Tweed logo is visible in the bottom right.

CLIPPED RHYTHM

Factory sample settings for Clipped Rhythm mode. The controls are: Input (Normal), Gain (High), Treble (High), Mid (High), Bass (High), Presence (High), 6V6 2-TWENTY (High), Master (High), Multi-Watt (10W), Power (On), Standby (On). The California Tweed logo is visible in the bottom right.

FACTORY SAMPLE SETTINGS

VINTAGE O.D.

Factory sample settings for VINTAGE O.D. mode. The settings are as follows:

- GAIN:** Normal Input, Low
- TREBLE:** High
- MID:** High
- BASS:** High
- PRESENCE:** High
- MASTER:** High
- MULTI-WATT™:** 10W
- POWER:** ON
- STANDBY:** ON

California tweed™

JAZZ CLEAN

Factory sample settings for JAZZ CLEAN mode. The settings are as follows:

- GAIN:** Normal Input, Low
- TREBLE:** High
- MID:** High
- BASS:** High
- PRESENCE:** High
- MASTER:** High
- MULTI-WATT™:** 10W
- POWER:** ON
- STANDBY:** ON

California tweed™

SQUEAKY CLEAN

Factory sample settings for SQUEAKY CLEAN mode. The settings are as follows:

- GAIN:** Normal Input, Low
- TREBLE:** High
- MID:** High
- BASS:** High
- PRESENCE:** High
- MASTER:** High
- MULTI-WATT™:** 10W
- POWER:** ON
- STANDBY:** ON

California tweed™

SINGING VINTAGE LEAD

Factory sample settings for SINGING VINTAGE LEAD mode. The settings are as follows:

- GAIN:** Normal Input, Low
- TREBLE:** High
- MID:** High
- BASS:** High
- PRESENCE:** High
- MASTER:** High
- MULTI-WATT™:** 10W
- POWER:** ON
- STANDBY:** ON

California tweed™

FULL TILT

Factory sample settings for FULL TILT mode. The settings are as follows:

- GAIN:** Normal Input, Low
- TREBLE:** High
- MID:** High
- BASS:** High
- PRESENCE:** High
- MASTER:** High
- MULTI-WATT™:** 10W
- POWER:** ON
- STANDBY:** ON

California tweed™

USER SETTINGS

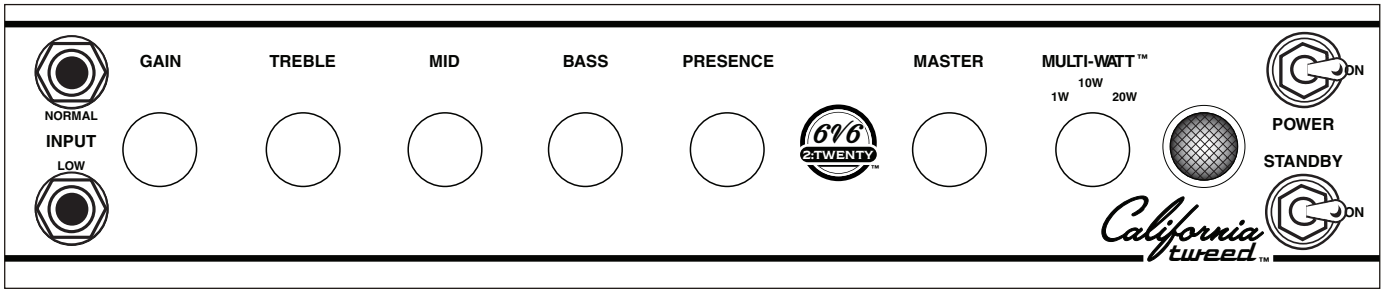

Control panel diagram 1 showing knobs for GAIN, TREBLE, MID, BASS, PRESENCE, MASTER, and MULTI-WATT™ (1W, 10W, 20W). Includes input selector (NORMAL, INPUT, LOW), 6V6 2TWENTY tube logo, and POWER/STANDBY switches. The California tweed™ logo is at the bottom right.

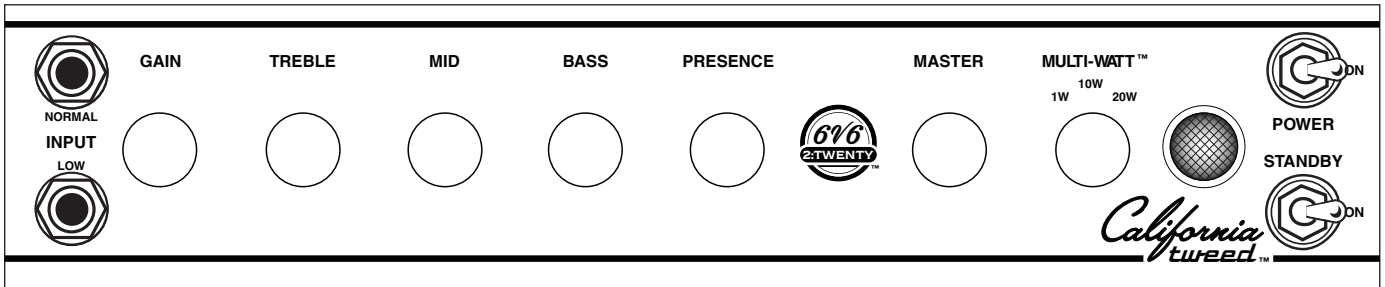

Control panel diagram 2, identical to diagram 1, showing knobs for GAIN, TREBLE, MID, BASS, PRESENCE, MASTER, and MULTI-WATT™ (1W, 10W, 20W). Includes input selector (NORMAL, INPUT, LOW), 6V6 2TWENTY tube logo, and POWER/STANDBY switches. The California tweed™ logo is at the bottom right.

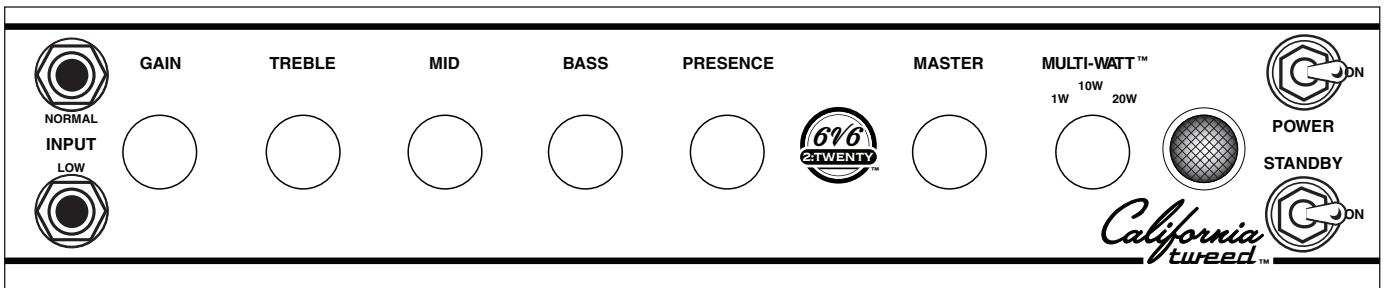

Control panel diagram 3, identical to diagram 1, showing knobs for GAIN, TREBLE, MID, BASS, PRESENCE, MASTER, and MULTI-WATT™ (1W, 10W, 20W). Includes input selector (NORMAL, INPUT, LOW), 6V6 2TWENTY tube logo, and POWER/STANDBY switches. The California tweed™ logo is at the bottom right.

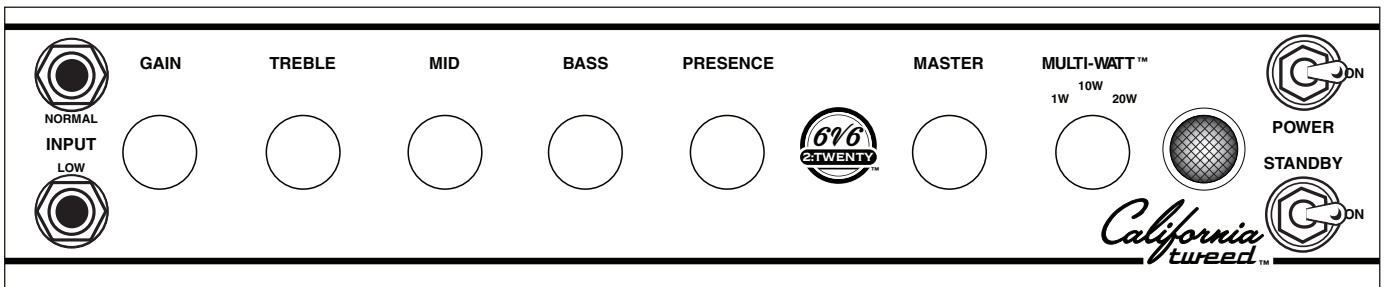

Control panel diagram 4, identical to diagram 1, showing knobs for GAIN, TREBLE, MID, BASS, PRESENCE, MASTER, and MULTI-WATT™ (1W, 10W, 20W). Includes input selector (NORMAL, INPUT, LOW), 6V6 2TWENTY tube logo, and POWER/STANDBY switches. The California tweed™ logo is at the bottom right.

USER SETTINGS

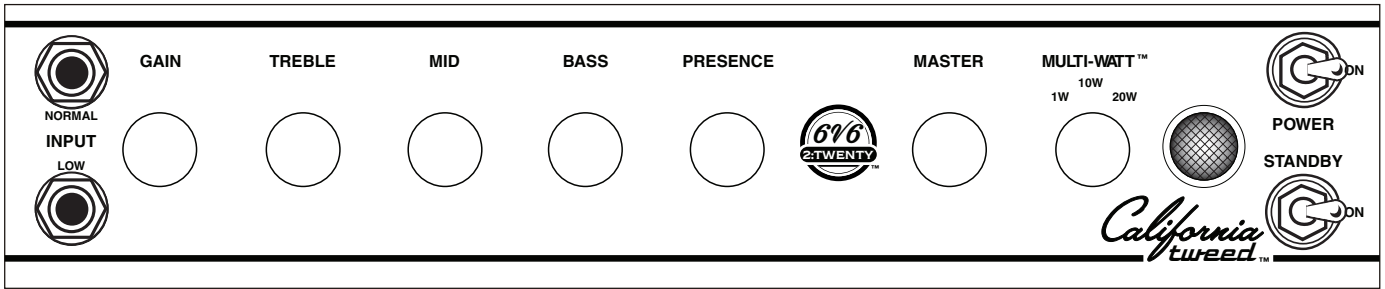

Control panel diagram 1 showing knobs for GAIN, TREBLE, MID, BASS, PRESENCE, MASTER, and MULTI-WATT™ (1W, 10W, 20W). Includes input selector (NORMAL, INPUT, LOW), 6V6 2TWENTY tube logo, and POWER/STANDBY switches. The California tweed™ logo is at the bottom right.

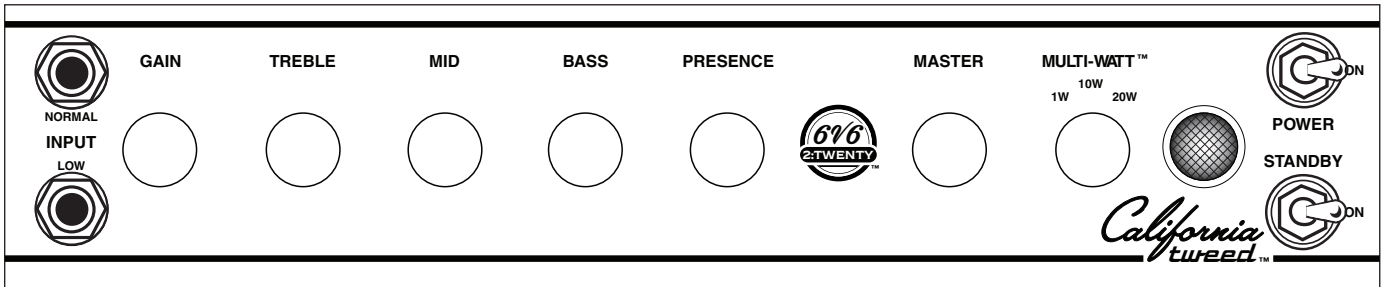

Control panel diagram 2, identical to diagram 1, showing knobs for GAIN, TREBLE, MID, BASS, PRESENCE, MASTER, and MULTI-WATT™ (1W, 10W, 20W). Includes input selector (NORMAL, INPUT, LOW), 6V6 2TWENTY tube logo, and POWER/STANDBY switches. The California tweed™ logo is at the bottom right.

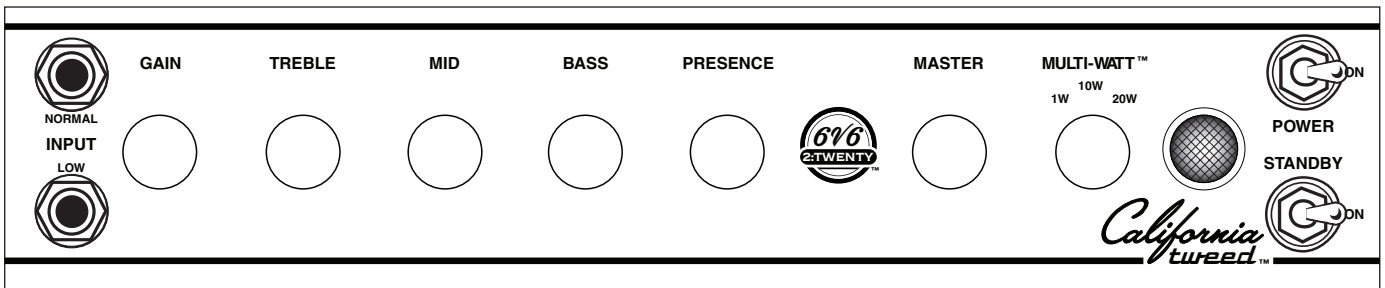

Control panel diagram 3, identical to diagram 1, showing knobs for GAIN, TREBLE, MID, BASS, PRESENCE, MASTER, and MULTI-WATT™ (1W, 10W, 20W). Includes input selector (NORMAL, INPUT, LOW), 6V6 2TWENTY tube logo, and POWER/STANDBY switches. The California tweed™ logo is at the bottom right.

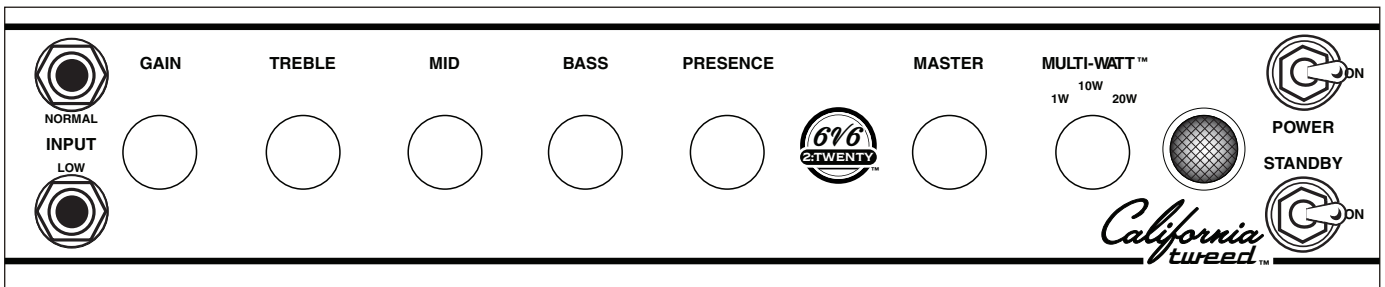

Control panel diagram 4, identical to diagram 1, showing knobs for GAIN, TREBLE, MID, BASS, PRESENCE, MASTER, and MULTI-WATT™ (1W, 10W, 20W). Includes input selector (NORMAL, INPUT, LOW), 6V6 2TWENTY tube logo, and POWER/STANDBY switches. The California tweed™ logo is at the bottom right.

DIAGNOSING PRE-AMP TUBE PROBLEMS

Because your amplifier is an all tube design, it is quite possible that you will at some point experience minor pre-amp tube noise. Rest assured - this is no cause for alarm and you can take care of the problem yourself in a matter of minutes by simply swapping tubes.

Let us begin by saying; It is a “very good” idea to keep at least a couple of spare pre-amp tubes on hand at all times to insure uninterrupted performance. These minor pre-amp tube problems can take many forms but can generally be described in two categories: Noise and Microphonics. Noise can be in the form of crackling, sputtering, white noise/hiss and/or hum. Microphonic problems usually appear in the form of a ringing or high pitched squealing that gets worse as the gain or volume is increased thus are more noticeable in the higher gain “HI” modes. Microphonic problems are easily identified because the problem is still present even with the instruments’ volume off or unplugged altogether - unlike pick-up feedback which ceases as the instrument is turned down. Microphonic noise is caused by mechanical vibration and shock: think of banging a microphone around and you’ll understand where the word came from.

The best way to approach a pre-amp tube problem is to see if it occurs only in one specific mode or channel. This should lead you to the tube needing replacement. Then all that remains is to swap the suspect tube for a known good performer. If you cannot narrow down the trouble to a specific mode or channel, the problem may be the small tube that drives the power tubes which is operational in all modes and channels. Though rare, a problem with the driver tube would show up in all aspects of performance - so if you can’t narrow the problem down to being mode or channel specific, you may want to try replacing the driver tube. Driver problems generally show themselves in the form of crackling or hum in all modes of performance and/or weak overall output from the amplifier. Occasionally an anemic driver tube will cause the amplifier to sound flat and lifeless, but this is somewhat uncommon, as worn power tubes are a more likely suspect for this type of problem.

Sometimes making the diagnosis is more trouble than it’s worth and it’s faster and easier to merely replace the small pre-amp tubes **ONE AT A TIME** with a replacement known to be good. But **MAKE SURE** you keep returning the tubes to their original socket until you hit the one that cures the problem. You’ll notice that tubes located nearer to the **INPUT** jack always sound noisier...but this is because they are at the start of the chain and their noise gets amplified over and over by the tubes that follow. The tube that goes into this “input socket” (usually labeled **V1**) needs to be the least noisy of the bunch. The tube that goes at the end of the preamp chain - just ahead of the power tubes - can be quite noisy without causing any problem at all. The tubes in your amp have already been located in the most appropriate sockets and this is why you should **NEVER** pull them all out at once and **ALWAYS** swap them one at a time. **ALWAYS** return a perfectly good tube to its original socket. Also it’s a good idea to put the amp on **STANDBY** when swapping tubes to reduce the heat build up in the tubes themselves and to prevent explosive noises (which can still occur even if you are pulling the tubes away from their sockets gently) from coming through the speaker.

Remember, take your time, be patient and chances are real good that you can fix your amp yourself by finding and replacing the bad tube. It kills us to see someone who has shipped their amp back to us...and all it needed was a simple tube replacement! If you must send back your amp, remove the chassis from the cabinet by unscrewing the four mounting bolts on the bottom top. The chassis then slides back like a drawer and comes out from the back. Remove the big power tubes and mark them according to their location from left to right 1, 2 etc. They need to be wrapped separately with plenty of wadded up newspaper around them and put in a smaller box within the larger carton. Remove the Rectifier tubes and wrap them also. You can leave the preamp tubes in or remove them and wrap them separately being sure to label their location. (See Tube Task Chart.)

To wrap the chassis, use plenty of tightly wadded up newspaper so there is at least six inches of “crush space” between the chassis and the cardboard box. Bubble wrap also works well, but please **DON’T** use styrene peanuts - they will shift during transit and get lodged inside your electronics as well as allowing your amp to

end up at the bottom of the box unprotected and possibly damaged.

Pre-amp tubes don't normally wear out as a rule. Therefore, it is not a good idea to change them just for the sake of changing them. If there isn't a problem - don't fix it. If there is no result from your substitutions, it may be possible that you have more than one problematic tube. Though rare, this does happen and though it makes the troubleshooting process a little more intimidating, it is still possible to cure the problem yourself.

NOTE: It is normal to hear a slight metallic ringing sound when tapping on the preamp tubes. As long as the tube does not break into oscillation or start crackling or any other form of bizarre noise, it is considered normal and functional.

TUBE NOISE & MICROPHONICS

You may occasionally experience some form of tube noise or microphonics. Certainly no cause for alarm, this quirky behavior comes with the territory and the tone. Much like changing a light bulb, you don't need a technician to cure these types of minor user serviceable annoyances and in fact, you'll be amazed at how easy it is to cure tube problems...by simply swapping out a pre-amp or power tube!

First may we suggest that you set the amplifier up on something so that you can get to the tubes comfortably without having to bend down. It also helps to have adequate lighting as you will need to see the tube sockets clearly to swap tubes. Use caution and common sense when touching the tubes after the amplifier has been on as they may be extremely hot! If they are hot and you don't want to wait for them to cool off, try grasping them with a rag and also note that the glass down around the bulbous silvery tip is considerably less hot which makes it easier to handle. Gently rock the tube back and forth as you pull it away from its socket.

DIAGNOSING POWER TUBE FAILURE

There are two main types of tube faults: shorts and noise. Both large and small tubes may fall prey to either of these problems but diagnosis and remedy is usually simple.

If a fuse blows, the problem is most likely a shorted power tube and shorts can either be mild or severe. In a mildly shorted tube the electron flow has overcome the control grid and excess current flows to the plate. You will usually hear the amp become distorted and begin to hum slightly. If this occurs, quickly look at the power tubes as you switch the amp to STANDBY and try to identify one as glowing red hot. It is likely that two of a pair will be glowing since the "shorted" tube will pull down the bias for its adjacent mates, but one tube may be glowing hotter — and that one is the culprit. The other two are often fine — unless they've been glowing bright red for several minutes.

Because there is no physical short inside the tube (just electrons rioting out of control) merely switching to STANDBY for a few moments then back to ON will usually cure the problem...at least temporarily. Watch the tubes carefully now. Should the problem recur, the intermittent tube will visibly start to over heat before the others and thus it can be identified. It should be replaced with one from the same color batch, shown on its label. Call us and we will send one out to you.

The severe short is not nearly so benign. In the worst cases, a major arcing short occurs between the plate and the cathode with visible lightning inside the glass and a major noise through the speaker. If this is seen to happen, IMMEDIATELY turn the amp to STANDBY. By this time the fuse probably will have blown. Such a short is usually caused by a physical breakdown inside the tube including contaminate coming loose or physical contact (or near contact) between the elements. Replace it and the fuse with the proper slo-blo type and power up the amp using the power up procedure as we described earlier in this manual.

TUBE NOISE

Often caused by contamination within in a tube, the culprit can usually be identified, and by lightly tapping on

the glass, you will probably hear the noise change. Hearing some noise through the speakers while tapping on the 12AX7's is normal however. And the one nearer the INPUT will always sound louder because its output is being further amplified by the second 12AX7.

The power tubes should be all but quiet when they are tapped. If crackling or hissing changes with the tapping, you have probably found the problem. To confirm a noisy power tube, merely put the amplifier on Standby, remove it from its socket and turn it back on. It will cause no damage to run the amplifier briefly with one power tube missing. You may notice a slight background hum, however, as the push-pull becomes unbalanced. Whenever you are trying to diagnose a suspect tube, keep your other hand on the POWER and STANDBY switches ready to shut them off instantly in the unlikely case you provoke a major short.

If you think you've located a problem tube but aren't sure, we recommend substituting the suspect with a new one just to be sure of your diagnoses. You will be doing yourself and us a big favor by just following the simple guidelines previously mentioned regarding tube replacement. You'll probably be successful with much less effort than is required to disconnect everything and haul the unit to a technician who will basically perform the same simple tests. If the tubes are still within their six-month warranty period, we will happily send you a replacement. Just note the color designation on the tube label so that we can send you the appropriate match.

SPEAKER IMPEDANCE MATCHING & HOOK-UP GUIDE

IMPEDANCE

Wiring up speakers to provide the most effective load and making sure that all of them are in phase will help in creating the best sound possible. This is not too difficult, as long as you understand a few things about loading and how to connect your speakers to provide an optimal resistive load.

MESA/Boogie amplifiers can handle 4 and 8 ohms effectively. Never run below 4 ohms in a tube amplifier unless you are absolutely certain that the system can handle it properly; this can cause damage to the Output transformer. A few amplifiers can handle 2 ohms effectively without damaging them (for example the MESA'S Bass 400+). You can always have a higher resistance (16 ohms, for example) without damaging results, but too low of a resistance will likely cause problems.

MIS-MATCHING

When running a higher resistance (for example: 8 ohm output into 16 ohm cabinet), a slightly different feel and response will be eminent. A slight mismatch can provide a darker smoother tone with a little less output and attack. This response is a result of the amplifier running a bit cooler. Sometimes when using more than one cabinet a mismatch will be the only option.

WHAT IS MY CABINETS IMPEDANCE?

If you have only a single speaker, you just match that single speakers impedance to the amplifier, and you are done. In many cases, you will have a number of speakers, and then you must calculate the "load" that the amplifier will need to support. There are generally three ways to wire multiple speakers together. They are as follows:

SERIES

When you wire (hook-up) speakers in Series, the speakers resistance (as measured in ohms) is additive - i.e. putting two 8 ohm speakers in Series results in a 16 ohm load.

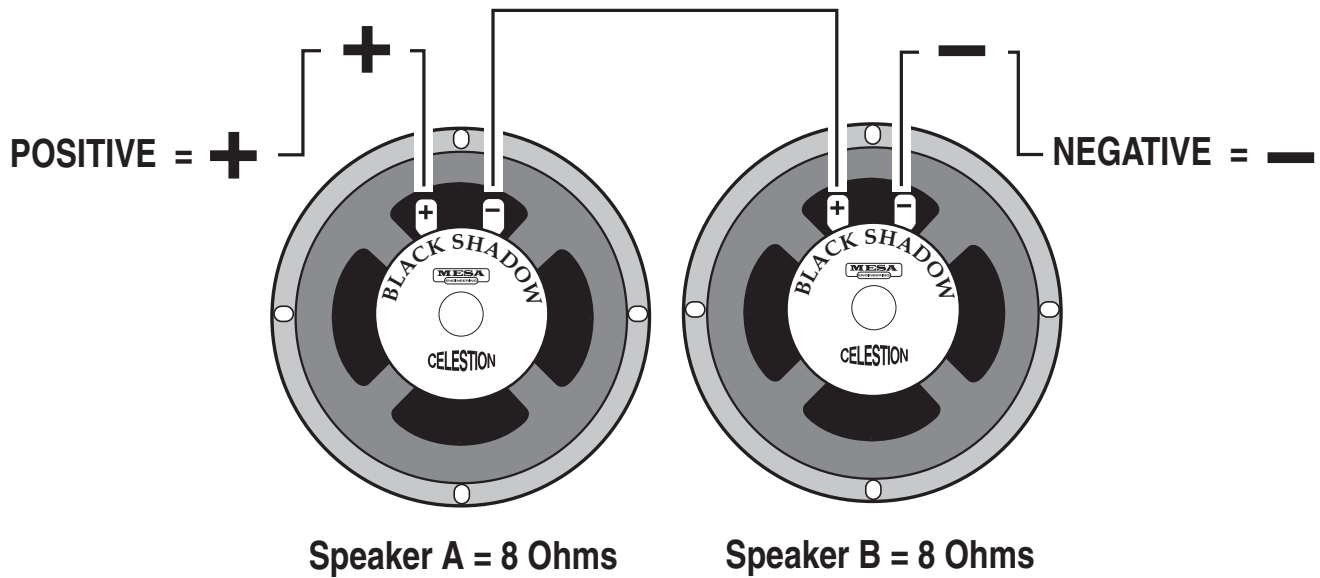

SERIES: Connect the Negative side of Speaker A to the Positive side of Speaker B

PARALLEL

When wiring in parallel, the resistance of the speakers decreases. Two 8 ohm speakers wired in (hooked-up) Parallel results in a 4 ohm load. It's easy to calculate the effect of a resistive load when all the speakers are all the same resistance. It is really not suggested to wire different resistive load values in Parallel (8 and 4, 16 and 8 etc.) The formula for figuring the total impedance in Parallel is the multiplication of the two loads divided by the sum of the two loads - i.e. putting two 8 ohm speakers in Parallel results in a 4 ohm load. Connect the Positive side of Speaker A to the Positive side of Speaker B - Connect the Negative side of Speaker A to the Negative side of Speaker B.

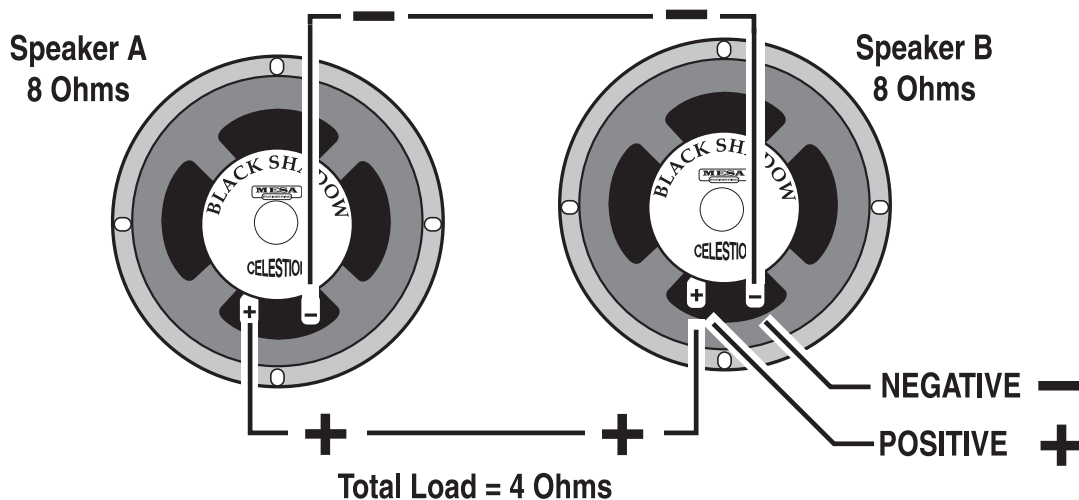

COMBINATION OF SERIES & PARALLEL

This is really just two sets of Series wired speakers connected in Parallel. This is how you maintain a consistent load with multiple speakers. The importance of this is more evident when you have more than one cabinet to connect to your amplifier. This is when you need to figure out the loads and how to wire them up without applying too low of a resistance on the amplifier.

Simply connect the Positive side of Speaker A to the Positive side of Speaker C.

Connect the Negative side of Speaker A to the Positive side of Speaker B. Next, connect the Negative side of Speaker C to the Positive side of Speaker D.

And lastly, connect the Negative side of Speaker B to the Negative side of Speaker D.

4 Eight (8) Ohm speakers wired in Series Parallel = a Total Load of 8 Ohms.

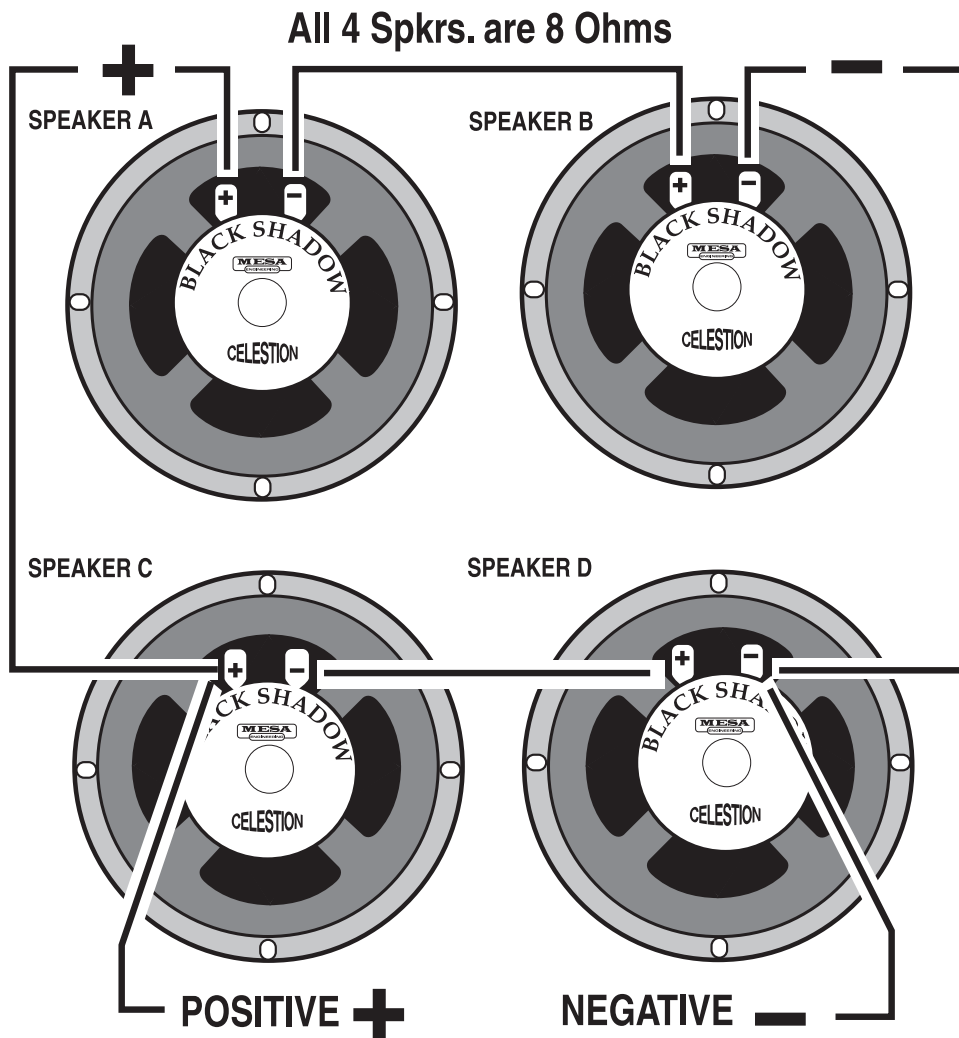

WIRING SCHEMES...Amplifier to Speaker Cabinets

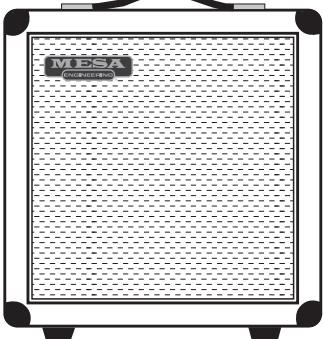
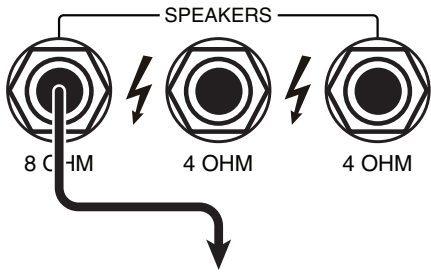

1

8 Ohm Cabinet

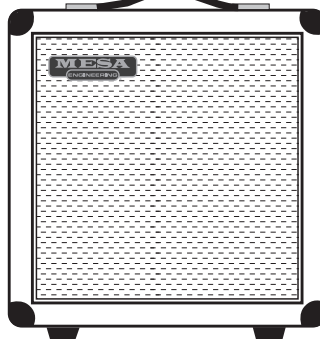
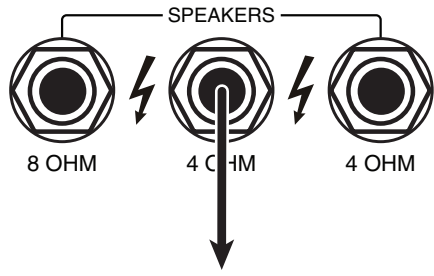

2

4 Ohm Cabinet

3

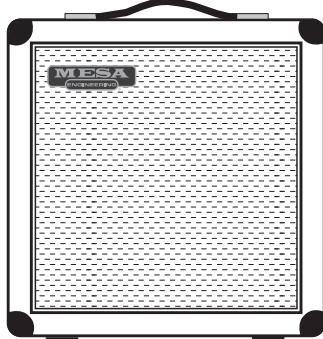
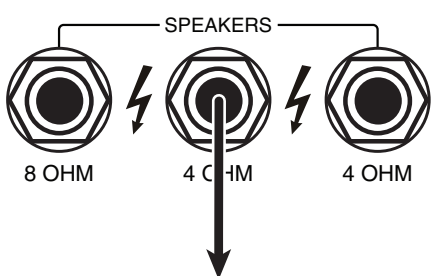

**8 Ohm Cabinet
SAFE MISMATCH**

4

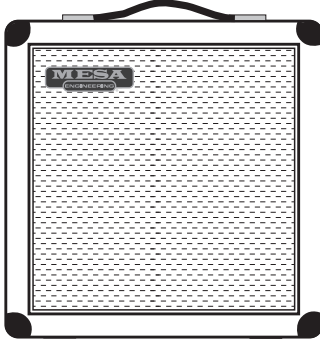
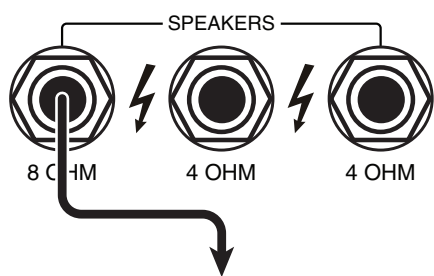

**16 Ohm Cabinet
SAFE MISMATCH**

WIRING SCHEMES...Amplifier to Speaker Cabinets

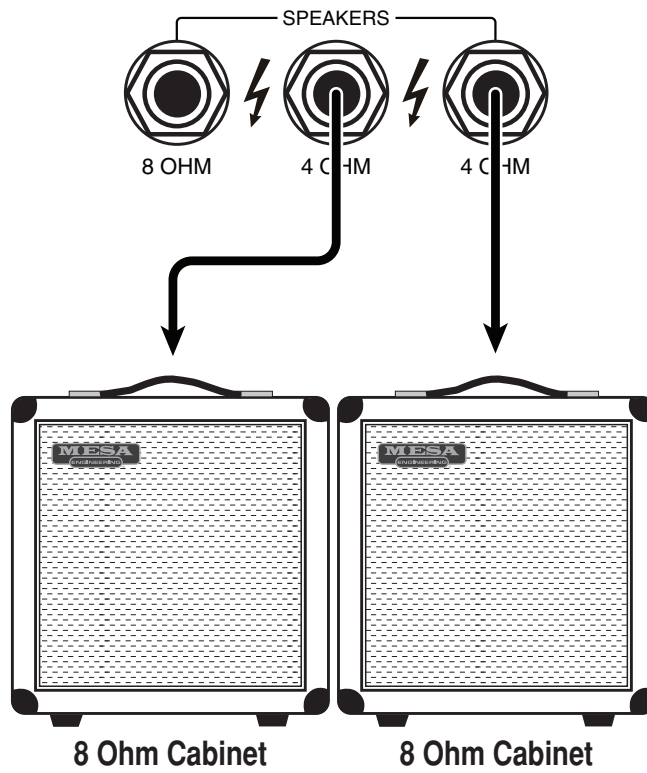

5

PLAYER NOTES AND REMINDERS

Lined writing area for player notes and reminders.

CALIFORNIA TWEED™ 2:TWENTY

TUBE REPLACEMENT DIAGRAM

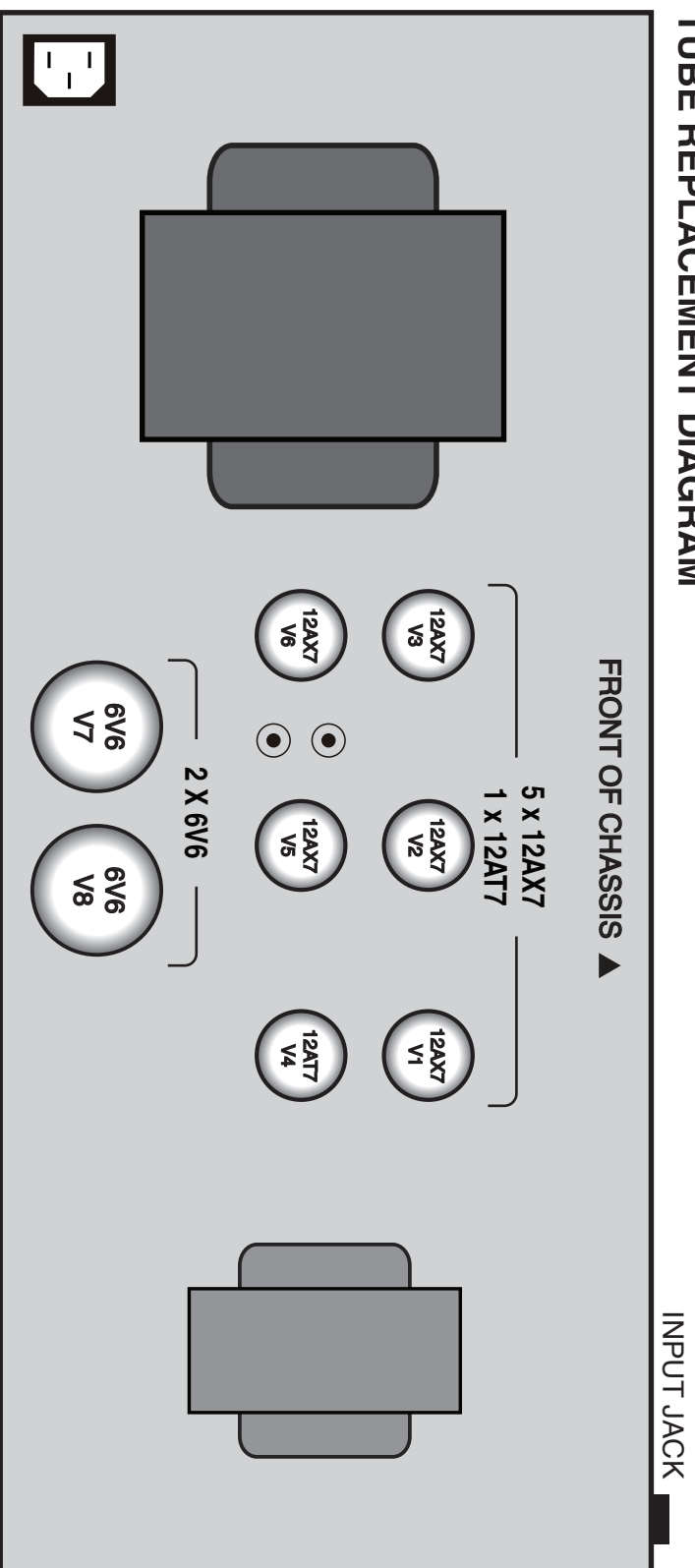

PREAMP TUBES

V1A • INPUT STAGE
 V1B • N/A
 V2A/B • TONE CONTROL DRIVER
 V3A • EFFECTS LOOP SEND
 V3B • EFFECTS LOOP RETURN

V4A/B • REVERB SEND STAGE
 V5A/B • DRIVER/PHASE INVERTER
 V6A • REVERB RETURN
 V6B • REVERB MIXER

POWER TUBES

20W • V7, V8 PENTODE
 10W • V7, V8 TRIODE
 1W • V7 PENTODE

TO MAINTAIN WARRANTY, USE MESA/BOOGIE® TUBES WHEN REPLACEMENT IS NECESSARY

FRONT PANEL: CALIFORNIA TWEED™ 2:TWENTY

ALL FRONT KNOBS
PT# 408660

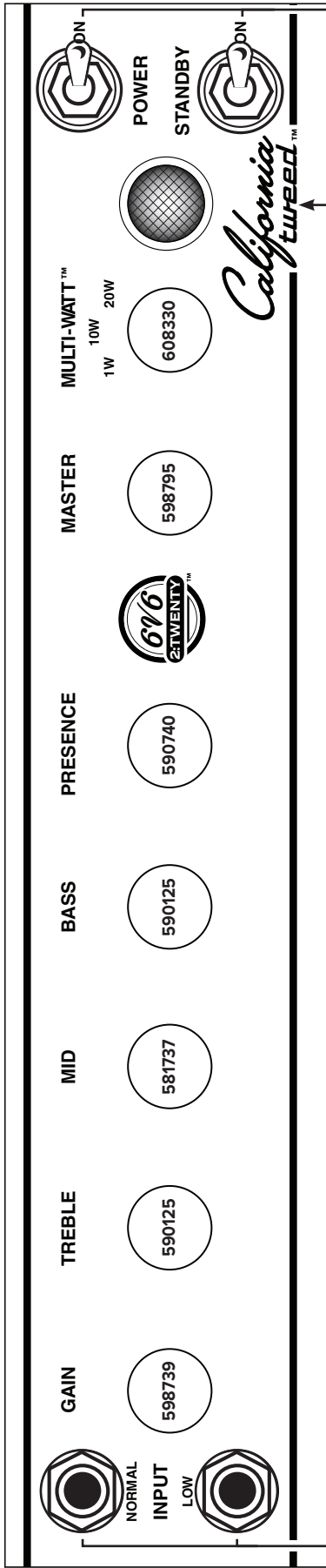

2 x JACK pt# 619112
2 x WASHER pt# 300063

LENS pt# 703601
BULB pt# 703047
HOLDER pt#
0703850

SWITCH x 2
pt# 600626

REAR PANEL: CALIFORNIA TWEED™ 2:TWENTY

REVERB KNOB
PT# 408661

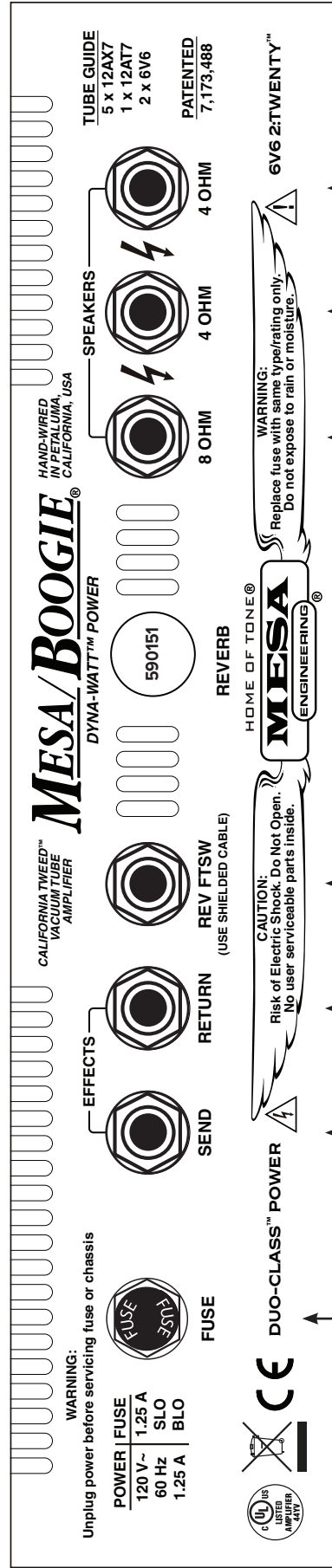

WARNING:
Unplug power before servicing fuse or chassis

POWER	120 V~
FUSE	1.25 A SLO
	60 Hz BLO
	1.25 A



DOMESTIC
FUSE: 790125
HOLDER: 790347

EXPORT
FUSE: 795630
HOLDER: 790346

CAUTION:
Risk of Electric Shock. Do Not Open.
No user serviceable parts inside.



WARNING:
Replace fuse with same type/rating only.
Do not expose to rain or moisture.

JACK x 3
pt# 619112

JACK x 3
pt# 619112



SERVICE INFORMATION

- **USA /CANADA Customer Support:**

For technical support, troubleshooting, tone questions, settings help and more...
707-778-6565 Monday-Thursday, 9 AM-5 PM Pacific Time

NOTE: If a Product Specialist is not available when you call (helping other customers), PLEASE leave a voice message with a phone number and a good time to call and WE'LL CALL YOU BACK!

- **INTERNATIONAL Customer Support:**

For warranty and technical support, please contact your LOCAL MESA DISTRIBUTOR.
You may use this link to search the web for your local distributor's contact information:



www.mesaboogie.com/support/

MESA/BOOGIE[®]

Thank you for trusting MESA/Boogie[®] to be your amplifier company and we wish you many years of toneful enjoyment from this handcrafted instrument.



Scan to download Mesa/Boogie product manuals in additional languages.
Or, visit www.mesaboogie.com/manuals

MESA/BOOGIE[®]

1317 Ross Street, Petaluma, CA 94954 USA • (707) 778-6565 • www.mesaboogie.com

24/10/24